



maasco



FIYAT LİSTESİ 2024

satis@maasco.com.tr
0 (212) 255 05 69

online Satış Mağazası
www.maascoelektrik.com

SIKMALI KABLO PABUÇLARI

STANDART TIP KABLO PABUCU

İMALATIMIZ



ÜRÜN KODU	KABLO KESİTİ (mm ²)	EBATLAR (mm)									AMBALAJ MİKTARI (KUTU)	FİYAT (TL / ADET)
		d	d1	d2	l	l1	a	b	c1	c2		
S-006	M5	5.3	5.3	5.3	26.5	21.5	10	11.5	6.1	9	1000	10,00
S-010	M5	5.3	4.7	6.6	27.5	22	11.3	10.3	5.5	7	800	11,50
S-010	M6	6.4	4.7	6.6	27.5	22	11.3	10.3	5.5	7	800	12,90
S-010	M8	8.3	4.7	6.6	27.5	22	11.3	10.3	5.5	7	700	12,10
S-010	M10	10.3	4.7	6.6	27.5	22	11.3	10.3	5.5	7	700	12,50
S-016	M6	6.4	5.6	7.8	29.5	24	13	11.2	5.5	6.5	500	15,65
S-016	M8	8.3	5.6	7.8	29.5	24	13	11.2	5.5	6.5	500	16,00
S-016	M10	10.3	5.6	7.8	29.5	24	13	11.2	5.5	6.5	500	16,40
S-025	M8	8.3	7.1	9.5	39	32.2	17.6	13.7	6.8	9.2	300	25,00
S-025	M10	10.3	7.1	9.5	39	32.2	17.6	13.7	6.8	9.2	300	25,50
S-025	M12	12.8	7.1	9.5	39	32.2	17.6	13.7	6.8	9.2	300	26,20
S-035	M8	8.3	8.2	10.8	44	35.7	19.9	15.3	8.3	9.7	200	36,50
S-035	M10	10.3	8.2	10.8	44	35.7	19.9	15.3	8.3	9.7	200	37,15
S-035	M12	12.8	8.2	10.8	44	35.7	19.9	15.3	8.3	9.7	200	38,00
S-050	M8	8.3	10.1	13	50.5	40.5	21.6	18.9	10	12	150	49,30
S-050	M10	10.3	10.1	13	50.5	40.5	21.6	18.9	10	12	150	49,50
S-050	M12	12.8	10.1	13	50.5	40.5	21.6	18.9	10	12	150	50,15
S-070	M8	8.3	11.5	14.7	54.6	44.6	24.1	21.1	10	12	100	63,75
S-070	M10	10.3	11.5	14.7	54.6	44.6	24.1	21.1	10	12	100	64,75
S-070	M12	12.8	11.5	14.7	54.6	44.6	24.1	21.1	10	12	100	65,50
S-070	M14	14.5	11.5	14.7	54.6	44.6	24.1	21.1	10	12	100	66,50
S-095	M8	8.3	13.5	16.7	58.8	48.8	27.2	24.7	10	12	100	78,70
S-095	M10	10.3	13.5	16.7	58.8	48.8	27.2	24.7	10	12	100	79,50
S-095	M12	12.8	13.5	16.7	58.8	48.8	27.2	24.7	10	12	100	82,00
S-095	M14	14.5	13.5	16.7	58.8	48.8	27.2	24.7	10	12	100	83,00
S-120	M10	10.3	15.6	19	69	56	30.5	27.7	13	14.5	50	105,00
S-120	M12	12.8	15.6	19	69	56	30.5	27.7	13	14.5	50	105,00
S-120	M14	14.5	15.6	19	69	56	30.5	27.7	13	14.5	50	105,00
S-150	M12	12.8	16.5	21	76.5	60	31.5	30.4	16.5	16.5	40	150,00
S-150	M14	14.5	16.5	21	76.5	60	31.5	30.4	16.5	16.5	40	150,00
S-150	M16	16.5	16.5	21	76.5	60	31.5	30.4	16.5	16.5	40	150,00

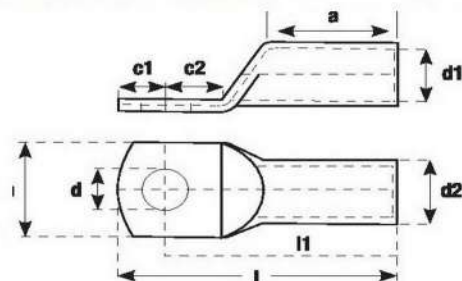

SIKMALI KABLO PABUÇLARI

STANDART TIP KABLO PABUCU

İMALATIMIZ

YERLİ
ÜRETİM

ÜRÜN KODU	KABLO KESİTİ (mm ²)	EBATLAR (mm)									AMBALAJ MİKTARI (KUTU)	FİYAT (TL / ADET)
		d	d1	d2	l	l1	a	b	c1	c2		
S-185	M12	12.8	18.4	23	82.5	65.5	34.4	34.2	17	18	25	225,00
S-185	M14	14.5	18.4	23	82.5	65.5	34.4	34.2	17	18	25	225,00
S-185	M16	16.5	18.4	23	82.5	65.5	34.4	34.2	17	18	25	225,00
S-240	M12	12.8	21.2	26.4	89	72	39.1	38.7	17	18	20	285,00
S-240	M14	14.5	21.2	26.4	89	72	39.1	38.7	17	18	20	285,00
S-240	M16	16.5	21.2	26.4	89	72	39.1	38.7	17	18	20	285,00
S-300	M12	12.8	23.4	28.6	95	72	39.1	38.7	17	18	20	355,00
S-300	M14	14.5	23.4	28.6	95	72	39.1	38.7	17	18	20	355,00
S-300	M16	16.5	23.4	28.6	95	72	39.1	38.7	17	18	20	355,00
S-400	M12	12.8	26.8	32.8	104.7	79.8	39	48.3	24.8	22.2	10	475,00
S-400	M14	14.5	26.8	32.8	104.7	79.8	39	48.3	24.8	22.2	10	475,00
S-400	M16	16.5	26.8	32.8	104.7	79.8	39	48.3	24.8	22.2	10	475,00
S-400	M20	21	26.8	32.8	104.7	79.8	39	48.3	24.8	22.2	10	475,00
S-500	M12	12.8	29.8	38.4	115.5	93	49	54.9	25.2	22.2	10	910,00
S-500	M14	14.5	29.8	38.4	115.5	93	49	54.9	25.2	22.2	10	910,00
S-500	M16	16.5	29.8	38.4	115.5	93	49	54.9	25.2	22.2	10	910,00
S-500	M20	21	29.8	38.4	115.5	93	49	54.9	25.2	22.2	10	910,00
S-600	M12	12.8	34.6	44	133	110	61	63	23	23	6	1580,00
S-600	M14	14.5	34.6	44	133	110	61	63	23	23	6	1580,00
S-600	M16	16.5	34.6	44	133	110	61	63	23	23	6	1580,00
S-600	M20	21	34.6	44	133	110	61	63	23	23	6	1580,00

* EN 13600 STANDARTLARINDA VE SERTİFİKALI BAKIRDAN İMAL EDİLMİŞTİR.

* 3-6 MİCRON ARASINDA KALAY KAPLIDIR.

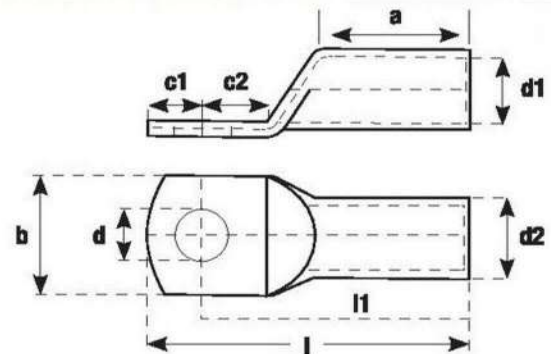

SIKMALI KABLO PABUÇLARI

EKONOMİK TİP KABLO PABUCU

İMALATIMIZ

YERLİ ÜRETİM

ÜRÜN KODU	KABLO KESİTİ (mm ²)	EBATLAR (mm)									AMBALAJ MİKTARI (KUTU)	FİYAT (TL / ADET)
		d	d1	d2	l	a	b	s	c1	c2		
E-016	M6	6.5	5.5	7	29.5	13	10	1.5	5.5	6.5	800	9,15
E-016	M8	8.5	5.5	7	29.5	13	10	1.5	5.5	6.5	800	9,25
E-025	M8	8.5	7	9	39	17.6	13	2	6.8	9.2	400	16,00
E-035	M8	8.5	8.5	10.5	44	19.9	15.5	2	8.3	9.7	300	23,75
E-035	M10	10.5	8.5	10.5	44	19.9	15.5	2	8.3	9.7	300	25,50
E-050	M8	8.5	10	12	50.5	21.6	17.6	2	10	12	200	31,50
E-050	M10	10.5	10	12	50.5	21.6	17.6	2	10	12	200	29,00
E-070	M10	10.5	11.5	14	54.6	24.1	20.5	2.5	10	12	150	48,00
E-070	M12	13	11.5	14	54.6	24.1	20.5	2.5	10	12	150	48,00
E-095	M10	10.5	13.5	16	58.8	27.2	23.5	2.5	10	12	100	54,00
E-095	M12	13	13.5	16	58.8	27.2	23.5	2.5	10	12	100	54,00
E-120	M12	13	15.5	18	69	30.5	26.7	2.5	13	14.5	50	74,00
E-150	M12	13	16.5	20	76.5	31.5	29.2	3.5	16.5	16.5	50	115,00
E-150	M14	15	16.5	20	76.5	31.5	29.2	2.3	16.5	16.5	50	115,00
E-185	M16	17	18.5	22	82.5	34.5	32.1	3.5	17	18	35	140,00
E-240	M14	15	21.5	25.5	89	39.1	37.6	4	17	18	30	215,00
E-240	M16	17	21.5	25.5	89	39.1	37.6	4	17	18	30	215,00

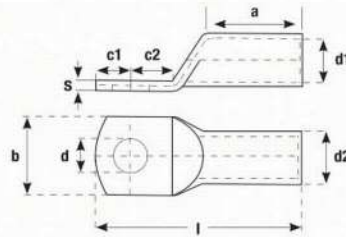

EK MUFLAR

İMALATIMIZ

YERLİ ÜRETİM

ÜRÜN KODU	EBATLAR (mm)			AMBALAJ MİKTARI (KUTU)	FİYAT (TL / ADET)
	d1	d2	l		
MEM-010	4.7	6.6	29	1000	9,75
MEM-016	5.6	7.8	31	800	16,50
MEM-025	7.1	9.5	40.5	350	25,50
MEM-035	8.2	10.8	45.5	250	38,50
MEM-050	10.1	13	52	200	55,00
MEM-070	11.5	14.7	56.1	125	76,50
MEM-095	13.5	16.7	60.3	50	89,50
MEM-120	15.6	19	70.5	50	128,50
MEM-150	16.5	21	79	50	195,00
MEM-185	18.4	23	85	25	240,00
MEM-240	21.2	26.4	91.5	20	315,00
MEM-300	23.4	28.6	98.5	15	385,00
MEM-400	26.8	32.8	108.5	10	495,00
MEM-500	29.8	38.4	120	5	935,00
MEM-600	34.5	44.7	137.6	5	1500,00

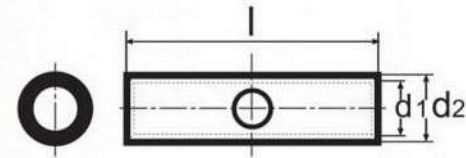

SIKMALI KABLO PABUÇLARI

EUROPE TİP SIKMALI KABLO PABUCU

İMALATIMIZ



ÜRÜN KODU	KABLO KESİTİ (mm ²)	EBATLAR (mm)									AMBALAJ MİKTARI (KUTU)	FİYAT (TL / ADET)
		d	d1	d2	l	l1	a	b	c1	c2		
S1-006	M5	5.3	5.3	5.3	34.4	21.5	10	11.5	6.1	9	1000	13,50
S1-010	M5	5.3	4.7	6.6	34.5	22	11.3	10.3	5.5	7	800	15,50
S1-010	M6	6.4	4.7	6.6	34.5	22	11.3	10.3	5.5	7	800	17,40
S1-010	M8	8.3	4.7	6.6	34.5	22	11.3	10.3	5.5	7	700	17,75
S1-010	M10	10.3	4.7	6.6	34.5	22	11.3	10.3	5.5	7	700	18,25
S1-016	M6	6.4	5.6	7.8	43.5	24	13	11.2	5.5	6.5	500	21,10
S1-016	M8	8.3	5.6	7.8	46	24	13	11.2	5.5	6.5	500	21,60
S1-016	M10	10.3	5.6	7.8	48	24	13	11.2	5.5	6.5	500	22,15
S1-025	M8	8.3	7.1	9.5	48	32.2	17.6	13.7	6.8	9.2	300	33,75
S1-025	M10	10.3	7.1	9.5	50	32.2	17.6	13.7	6.8	9.2	300	34,40
S1-025	M12	12.8	7.1	9.5	51	32.2	17.6	13.7	6.8	9.2	300	34,30
S1-035	M8	8.3	8.2	10.8	52	35.7	19.9	15.3	8.3	9.7	200	49,25
S1-035	M10	10.3	8.2	10.8	54	35.7	19.9	15.3	8.3	9.7	200	50,15
S1-035	M12	12.8	8.2	10.8	55	35.7	19.9	15.3	8.3	9.7	200	51,50
S1-050	M8	8.3	10.1	13	62	40.5	21.6	18.9	10	12	150	67,75
S1-050	M10	10.3	10.1	13	64	40.5	21.6	18.9	10	12	150	67,75
S1-050	M12	12.8	10.1	13	66	40.5	21.6	18.9	10	12	150	67,75
S1-070	M10	10.3	11.5	14.7	67	44.6	24.1	21.1	10	12	100	87,75
S1-070	M12	12.8	11.5	14.7	69	44.6	24.1	21.1	10	12	100	87,75
S1-095	M10	10.3	13.5	16.7	77	48.8	27.2	24.7	10	12	100	110,00
S1-095	M12	12.8	13.5	16.7	79	48.8	27.2	24.7	10	12	100	110,00
S1-120	M10	10.3	15.6	19	85	56	30.5	27.7	13	14.5	50	145,00
S1-120	M12	12.8	15.6	19	86	56	30.5	27.7	13	14.5	50	145,00
S1-120	M14	14.5	15.6	19	88	56	30.5	27.7	13	14.5	50	145,00
S1-150	M12	12.8	16.5	21	94	60	31.5	30.4	16.5	16.5	40	205,00
S1-150	M14	14.5	16.5	21	96	60	31.5	30.4	16.5	16.5	40	205,00
S1-150	M16	16.5	16.5	21	98	60	31.5	30.4	16.5	16.5	40	205,00
S1-150	M12	12.8	18.4	23	97	65.5	34.4	34.2	17	18	25	305,00
S1-150	M14	14.5	18.4	23	99	65.5	34.4	34.2	17	18	25	205,00
S1-150	M16	16.5	18.4	23	101	65.5	34.4	34.2	17	18	25	205,00

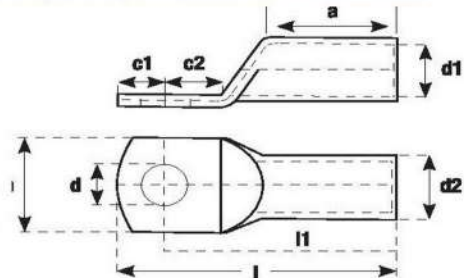

SIKMALI KABLO PABUÇLARI

EUROPE TİP SIKMALI KABLO PABUCU

İMALATIMIZ

YERLİ
ÜRETİM

ÜRÜN KODU	KABLO KESİTİ (mm ²)	EBATLAR (mm)									AMBALAJ MİKTARI (KUTU)	FİYAT (TL / ADET)
		d	d1	d2	l	l1	a	b	c1	c2		
S1-240	M12	12.8	21.2	29	89	72	39.1	38.7	17	18	20	305,00
S1-240	M14	14.5	21.2	29	89	72	39.1	38.7	17	18	20	305,00
S1-240	M16	16.5	21.2	29	89	72	39.1	38.7	17	18	20	305,00
S1-300	M12	12.8	23.4	32	95	72	39.1	38.7	17	18	20	370,00
S1-300	M14	14.5	23.4	32	95	72	39.1	38.7	17	18	20	370,00
S1-300	M16	16.5	23.4	32	95	72	39.1	38.7	17	18	20	370,00
S1-400	M12	12.8	26.8	38	104.7	79.8	39	48.3	24.8	22.2	10	490,00
S1-400	M14	14.5	26.8	38	104.7	79.8	39	48.3	24.8	22.2	10	490,00
S1-400	M16	16.5	26.8	38	104.7	79.8	39	48.3	24.8	22.2	10	490,00
S1-400	M20	21	26.8	38	104.7	79.8	39	48.3	24.8	22.2	10	490,00
S1-500	M12	12.8	29.8	42	115.5	93	49	54.9	25.2	22.2	10	940,00
S1-500	M14	14.5	29.8	42	115.5	93	49	54.9	25.2	22.2	10	940,00
S1-500	M16	16.5	29.8	42	115.5	93	49	54.9	25.2	22.2	10	940,00
S1-500	M20	21	29.8	42	115.5	93	49	54.9	25.2	22.2	10	940,00
S1-600	M12	12.8	34.6	44	133	110	61	63	23	23	6	1335,00
S1-600	M14	14.5	34.6	44	133	110	61	63	23	23	6	1335,00
S1-600	M16	16.5	34.6	44	133	110	61	63	23	23	6	1335,00
S1-600	M20	21	34.6	44	133	110	61	63	23	23	6	1335,00

* EN 13600 STANDARTLARINDA VE SERTİFİKALI BAKIRDAN İMAL EDİLMİŞTİR.

* 3-6 MİCRON ARASINDA KALAY KAPLIDIR.

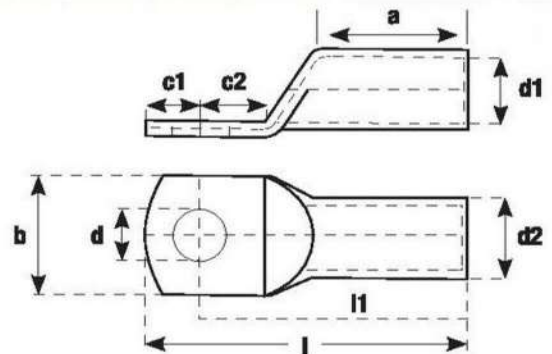

SIKMALI KABLO PABUÇLARI

DIN NORMU SIKMALI KABLO PABUCU

İMALATIMIZ

YERLİ
ÜRETİM

ÜRÜN KODU	KABLO KESİTİ (mm ²)	EBATLAR (mm)									AMBALAJ MİKTARI (KUTU)	FİYAT (TL / ADET)
		d	d1	d2	l	l1	a	b	c1	c2		
D-006	M5	5.3	5.3	6.6	34.4	21.5	10	11.5	6.1	9	1000	9,00
D-010	M5	5.3	4.7	7.0	34.5	22	11.3	10.3	5.5	7	800	12,00
D-010	M6	6.4	4.7	7.0	34.5	22	11.3	10.3	5.5	7	800	12,00
D-010	M8	8.3	4.7	7.0	34.5	22	11.3	10.3	5.5	7	700	12,30
D-010	M10	10.3	4.7	7.0	34.5	22	11.3	10.3	5.5	7	700	13,60
D-016	M6	6.4	5.6	8.2	43.5	24	13	11.2	5.5	6.5	500	16,80
D-016	M8	8.3	5.6	8.2	46	24	13	11.2	5.5	6.5	500	17,10
D-016	M10	10.3	5.6	8.2	48	24	13	11.2	5.5	6.5	500	17,40
D-025	M8	8.3	7.1	10	48	32.2	17.6	13.7	6.8	9.2	300	33,00
D-025	M10	10.3	7.1	10	50	32.2	17.6	13.7	6.8	9.2	300	32,80
D-025	M12	12.8	7.1	10	51	32.2	17.6	13.7	6.8	9.2	300	31,00
D-035	M8	8.3	8.2	12.5	52	35.7	19.9	15.3	8.3	9.7	200	39,80
D-035	M10	10.3	8.2	12.5	54	35.7	19.9	15.3	8.3	9.7	200	43,00
D-035	M12	12.8	8.2	12.5	55	35.7	19.9	15.3	8.3	9.7	200	43,00
D-050	M8	8.3	10.1	14.5	62	40.5	21.6	18.9	10	12	150	53,00
D-050	M10	10.3	10.1	14.5	64	40.5	21.6	18.9	10	12	150	57,00
D-050	M12	12.8	10.1	14.5	66	40.5	21.6	18.9	10	12	150	57,00
D-070	M10	10.3	11.5	16.5	67	44.6	24.1	21.1	10	12	100	77,00
D-070	M12	12.8	11.5	16.5	69	44.6	24.1	21.1	10	12	100	77,00
D-095	M10	10.3	13.5	19	77	48.8	27.2	24.7	10	12	100	98,00
D-095	M12	12.8	13.5	19	79	48.8	27.2	24.7	10	12	100	98,00
D-120	M10	10.3	15.6	21	85	56	30.5	27.7	13	14.5	50	140,00
D-120	M12	12.8	15.6	21	86	56	30.5	27.7	13	14.5	50	142,50
D-120	M14	14.5	15.6	21	88	56	30.5	27.7	13	14.5	50	146,00
D-150	M12	12.8	16.5	23	94	60	31.5	30.4	16.5	16.5	40	220,00
D-150	M14	14.5	16.5	23	96	60	31.5	30.4	16.5	16.5	40	218,40
D-150	M16	16.5	16.5	23	98	60	31.5	30.4	16.5	16.5	40	215,00
D-150	M12	12.8	18.4	25.5	97	65.5	34.4	34.2	17	18	25	265,00
D-150	M14	14.5	18.4	25.5	99	65.5	34.4	34.2	17	18	25	265,00
D-150	M16	16.5	18.4	25.5	101	65.5	34.4	34.2	17	18	25	262,00

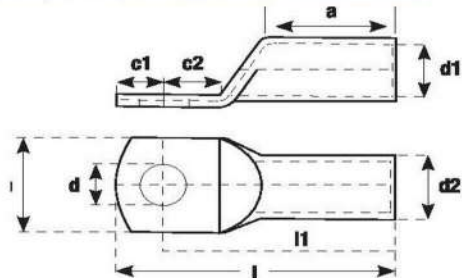

SIKMALI KABLO PABUÇLARI

DIN NORMU SIKMALI KABLO PABUCU

İMALATIMIZ

YERLİ
ÜRETİM

ÜRÜN KODU	KABLO KESİTİ (mm ²)	EBATLAR (mm)									AMBALAJ MİKTARI (KUTU)	FİYAT (TL / ADET)
		d	d1	d2	l	l1	a	b	c1	c2		
D-240	M12	12.8	21.2	29	89	72	39.1	38.7	17	18	20	350,00
D-240	M14	14.5	21.2	29	89	72	39.1	38.7	17	18	20	350,00
D-240	M16	16.5	21.2	29	89	72	39.1	38.7	17	18	20	350,00
D-300	M12	12.8	23.4	32	95	72	39.1	38.7	17	18	20	445,00
D-300	M14	14.5	23.4	32	95	72	39.1	38.7	17	18	20	445,00
D-300	M16	16.5	23.4	32	95	72	39.1	38.7	17	18	20	445,00
D-400	M12	12.8	26.8	38	104.7	79.8	39	48.3	24.8	22.2	10	570,00
D-400	M14	14.5	26.8	38	104.7	79.8	39	48.3	24.8	22.2	10	570,00
D-400	M16	16.5	26.8	38	104.7	79.8	39	48.3	24.8	22.2	10	570,00
D-400	M20	21	26.8	38	104.7	79.8	39	48.3	24.8	22.2	10	570,00
D-500	M12	12.8	29.8	42	115.5	93	49	54.9	25.2	22.2	10	1055,00
D-500	M14	14.5	29.8	42	115.5	93	49	54.9	25.2	22.2	10	1055,00
D-500	M16	16.5	29.8	42	115.5	93	49	54.9	25.2	22.2	10	1055,00
D-500	M20	21	29.8	42	115.5	93	49	54.9	25.2	22.2	10	1055,00
D-600	M12	12.8	34.6	44	133	110	61	63	23	23	6	1800,00
D-600	M14	14.5	34.6	44	133	110	61	63	23	23	6	1800,00
D-600	M16	16.5	34.6	44	133	110	61	63	23	23	6	1800,00
D-600	M20	21	34.6	44	133	110	61	63	23	23	6	1800,00

* EN 13600 STANDARTLARINDA VE SERTİFİKALI BAKIRDAN İMAL EDİLMİŞTİR.

* 3-6 MİCRON ARASINDA KALAY KAPLIDIR.

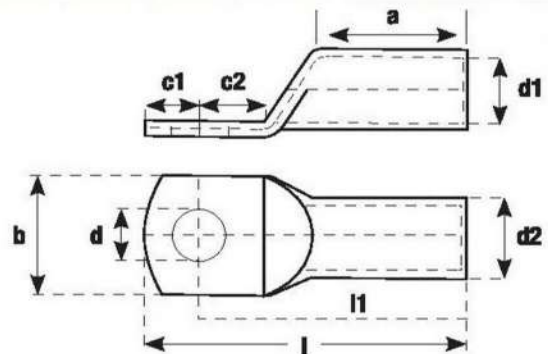

SIKMALI KABLO PABUÇLARI

İMALATIMIZ

YERLİ ÜRETİM

ÇİFT DELİKLİ KABLO PABUCU

ÜRÜN KODU	KABLO KESİTİ (mm ²)	EBATLAR (mm)					AMBALAJ MİKTARI (KUTU)	FİYAT (TL / ADET)
		A	C	L	D	X		
Ç-MSKP-16/X-16	M6	5.6	7.8	53.0	12.0	16.0	100	17,50
Ç-MSKP-16/X-25	M6	5.6	7.8	63.0	12.0	25.0	100	17,90
Ç-MSKP-25/X-16	M8	7.1	9.5	54.0	14.0	16.0	80	32,80
Ç-MSKP-25/X-25	M8	7.1	9.5	63.0	14.0	25.0	80	33,50
Ç-MSKP-35/X-25	M8	8.2	10.8	71.0	18.0	25.0	80	43,20
Ç-MSKP-35/X-40	M8	8.2	10.8	86.0	18.0	40.0	80	44,00
Ç-MSKP-50/X-25	M8	10.1	13.0	69.0	21.0	25.0	50	57,00
Ç-MSKP-50/X-40	M8	10.1	13.0	84.0	21.0	40.0	50	57,80
Ç-MSKP-50/X-25	M10	10.1	13.0	75.0	21.0	25.0	50	57,80
Ç-MSKP-50/X-40	M10	10.1	13.0	90.0	21.0	40.0	50	58,90
Ç-MSKP-70/X-25	M10	11.5	14.7	82.0	23.0	25.0	40	77,00
Ç-MSKP-70/X-40	M10	11.5	14.7	97.0	23.0	40.0	40	78,20
Ç-MSKP-70/X-25	M12	11.5	14.7	76.0	23.0	25.0	40	77,50
Ç-MSKP-70/X-40	M12	11.5	14.7	91.0	23.0	40.0	40	78,90
Ç-MSKP-95/X-40	M10	13.5	16.7	102	26.0	40.0	25	98,00
Ç-MSKP-95/X-40	M12	13.5	16.7	102	26.0	40.0	25	100,00
Ç-MSKP-95/X-45	M12	13.5	16.7	107	26.0	45.0	25	100,00
Ç-MSKP-95/X-60	M12	13.5	16.7	122	26.0	60.0	25	102,00
Ç-MSKP-120/X-25	M12	15.6	19.0	87.0	28.0	25.0	25	148,00
Ç-MSKP-120/X-40	M12	15.6	19.0	102	28.0	40.0	25	151,00
Ç-MSKP-120/X-45	M12	15.6	19.0	107	28.0	45.0	25	152,00
Ç-MSKP-120/X-60	M12	15.6	19.0	122	28.0	60.0	25	154,00
Ç-MSKP-150/X-25	M12	16.5	21.0	90.0	31.0	25.0	25	220,00
Ç-MSKP-150/X-40	M12	16.5	21.0	105	31.0	40.0	25	227,00
Ç-MSKP-150/X-45	M12	16.5	21.0	110	31.0	45.0	25	227,00
Ç-MSKP-150/X-60	M12	16.5	21.0	125	31.0	60.0	25	235,00
Ç-MSKP-185/X-25	M12	18.4	23.0	96.0	35.0	25.0	20	275,00
Ç-MSKP-185/X-40	M12	18.4	23.0	111	35.0	40.0	20	285,00
Ç-MSKP-185/X-45	M12	18.4	23.0	116	35.0	45.0	20	289,00
Ç-MSKP-185/X-60	M12	18.4	23.0	131	35.0	60.0	20	299,00
Ç-MSKP-240/X-25	M12	21.2	26.4	97.0	38.0	25.0	12	350,00
Ç-MSKP-240/X-40	M12	21.2	26.4	112	38.0	40.0	12	360,00
Ç-MSKP-240/X-45	M12	21.2	26.4	117	38.0	45.0	12	365,00
Ç-MSKP-240/X-60	M12	21.2	26.4	132	38.0	60.0	12	378,00

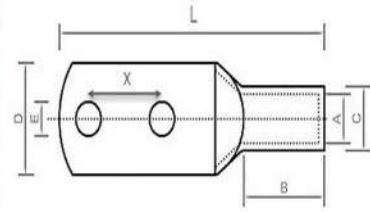

SIKMALI KABLO PABUÇLARI

DAR GİRİŞLİ KABLO PABUCU

İMALATIMIZ

YERLİ
ÜRETİM

ÜRÜN KODU	KABLO KESİTİ (mm ²)	EBATLAR (mm)									AMBALAJ MİKTARI (KUTU)	FİYAT (TL / ADET)
		d	d1	d2	l	l1	a	b	c1	c2		
DG-035	M6	6.4	8.2	10.8	44	35.7	19.9	15.3	8.3	9.7	200	45,00
DG-050	M6	6.4	10.1	13	50.5	40.5	21.6	18.9	10	12	150	58,90
DG-050	M8	8.3	10.1	13	50.5	40.5	21.6	18.9	10	12	150	61,50
DG-050	M10	10.3	10.1	13	50.5	40.5	21.6	18.9	10	12	150	64,90
DG-070	M8	8.3	11.5	14.7	54.6	44.6	24.1	21.1	10	12	100	77,00
DG-070	M10	10.3	11.5	14.7	54.6	44.6	24.1	21.1	10	12	100	80,00
DG-095	M8	8.3	13.5	16.7	58.8	48.8	27.2	24.7	10	12	100	100,00
DG-095	M10	10.3	13.5	16.7	58.8	48.8	27.2	24.7	10	12	100	109,00
DG-120	M8	8.3	15.6	19	69	56	30.5	27.7	13	14.5	50	155,00
DG-120	M10	10.3	15.6	19	69	56	30.5	27.7	13	14.5	50	163,00
DG-150	M8	8.3	16.5	21	76.5	60	31.5	30.4	16.5	16.5	40	235,00
DG-150	M10	10.3	16.5	21	76.5	60	31.5	30.4	16.5	16.5	40	235,00
DG-185	M10	10.3	18.4	23	82.5	65.5	34.4	34.2	17	18	25	299,99
DG-185	M12	12.8	18.4	23	82.5	65.5	34.4	34.2	17	18	25	299,99
DG-240	M12	12.8	10.1	13	50.5	40.5	21.6	18.9	10	12	20	350,00
DG-240	M14	14.5	10.1	13	50.5	40.5	21.6	18.9	10	12	20	350,00
DG-240	M16	16.5	10.1	13	50.5	40.5	21.6	18.9	10	12	20	350,00
DG-300	M12	12.8	10.1	13	50.5	40.5	21.6	18.9	10	12	20	450,00
DG-300	M14	14.5	10.1	13	50.5	40.5	21.6	18.9	10	12	20	450,00
DG-300	M16	16.5	10.1	13	50.5	40.5	21.6	18.9	10	12	20	450,00

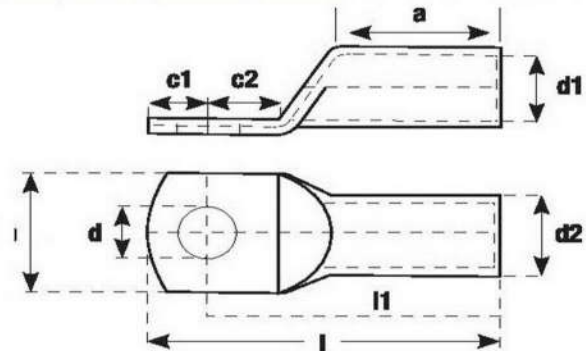

SIKMALI KABLO PABUÇLARI

BİMETAL (CU/AL) KABLO PABUCU



ÜRÜN KODU	KABLO KESİTİ (mm ²)	EBATLAR (mm)			AMBALAJ MİKTARI (KUTU)	FİYAT (TL / ADET)
		d1	l	b		
MB-16	M8	5,5	69,5	20	60	60,50
MB-16	M10	5,5	69,5	20	60	62,50
MB-25	M8	6,5	69,5	20	60	61,40
MB-25	M10	6,5	69,5	20	60	63,80
MB-35	M8	8,0	69,5	20	60	62,60
MB-35	M10	8,0	69,5	20	60	64,90
MB-50	M8	9,0	75,0	24	40	74,50
MB-50	M10	9,0	75,0	24	40	74,50
MB-70	M8	11,0	75,0	24	40	75,80
MB-70	M10	11,0	75,0	24	40	75,80
MB-95	M8	12,5	75,0	24	40	77,50
MB-95	M10	12,5	75,0	24	40	77,50
MB-120	M14	13,7	95,0	30	15	132,00
MB-120	M16	13,7	95,0	30	15	135,00
MB-150	M14	15,5	95,0	30	15	132,00
MB-150	M16	15,5	95,0	30	15	135,00
MB-185	M14	17,0	103,5	35	10	219,00
MB-185	M16	17,0	103,5	35	10	225,00
MB-240	M14	19,5	103,5	35	10	219,00
MB-240	M16	19,5	103,5	35	10	225,00
MB-300	M14	23,3	138,5	36	5	264,00
MB-300	M16	23,3	138,5	36	5	265,00
MB-400	M10	26,0	138,5	36	5	390,00
MB-400	M14	26,0	138,5	36	5	390,00
MB-500	M16	29,1	158,0	60	5	
MB-630	M16	32,5	158,0	60	5	

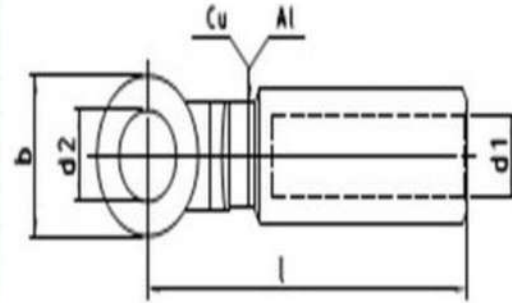

BİMETAL (CU/AL) EK-MUF



ÜRÜN KODU	EBATLAR (mm)							FİYAT (TL / ADET)
	L1	L2	L	D1	D2	D3	D4	
CU16-AL10	16	29	88	5,6	9,0	5,5	43	
CU16-AL16	16	29	88	5,6	12,2	5,5	43	
CU25-AL16	16	29	88	5,6	12,2	6,5	43	
CU25-AL25	16	29	88	7,0	12,2	6,5	43	
CU35-AL25	16	29	88	7,0	12,2	8	43	
CU35-AL35	20	29	90	8,0	12,2	8	43	
CU50-AL35	20	29	90	8,0	12,2	9	43	
CU50-AL50	20	29	90	9,5	12,2	9	43	
CU70-AL50	20	29	90	9,5	12,2	11	43	
CU70-AL70	20	29	90	11	12,2	11	43	



SIKMALI KABLO PABUÇLARI

BİMETAL (CU/AL) EK-MUF



ÜRÜN KODU	EBATLAR (mm)							FİYAT (TL / ADET)
	L1	L2	L	D1	D2	D3	D4	
CU95-AL70	20	33	90	21	11	12,5	43	
CU95-AL95	20	33	90	21	13	12,5	43	
CU120-AL95	25	33	107	21	13	13,7	59	
CU120-AL120	25	33	107	21	14,2	13,7	59	
CU150-AL120	25	33	107	21	14,2	15,5	59	
CU150-AL150	25	33	107	21	16	15,5	59	
CU185-AL150	32	33	107	26,2	16	17	59	
CU185-AL185	32	33	120	26,2	18	17	59	
CU240-AL185	32	43	120	26,2	18	19,5	59	
CU240-AL240	32	43	120	26,2	20	19,5	59	

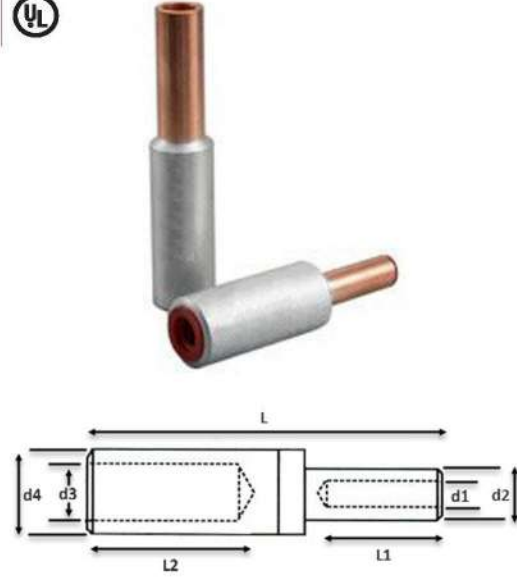

45 DERECE SIKMALI KABLO PABUCU



İMALATIMIZ

ÜRÜN KODU	KABLO KESİTİ (mm ²)	EBATLAR (mm)							FİYAT (TL / ADET)
		5,6	7,8	6,5	12,0	13,0	5,5	12,0	
45D-16	M6	5,6	7,8	6,5	12,0	13,0	5,5	12,0	17,50
45D-25	M8	7,1	9,5	8,5	17,5	13,5	6,8	16,0	32,50
45D-35	M8	8,2	10,8	8,5	20,0	16,0	8,3	18,0	43,00
45D-50	M10	10,0	13,0	10,5	22,5	18,0	10,0	22,0	65,00
45D-70	M10	11,5	14,7	10,5	24,0	21,0	10,0	22,0	78,00
45D-95	M10	13,5	16,7	10,5	27,0	25,0	10,0	22,0	102,00
45D-120	M12	15,6	19,0	13,0	30,0	29,0	13,0	27,5	155,00
45D-150	M12	16,5	21,0	13,0	30,0	31,0	14,0	31,0	230,00
45D-185	M16	18,4	23,0	17,0	34,0	37,0	17,0	31,0	285,00
45D-240	M16	21,2	26,4	17,0	35,5	41,0	17,0	35,0	345,00



90 DERECE SIKMALI KABLO PABUCU



İMALATIMIZ

ÜRÜN KODU	KABLO KESİTİ (mm ²)	EBATLAR (mm)							FİYAT (TL / ADET)
		5,6	7,8	6,5	12,0	13,0	5,5	12,0	
90D-16	M6	5,6	7,8	6,5	12,0	13,0	5,5	12,0	17,50
90D-25	M8	7,1	9,5	8,5	17,5	13,5	6,8	16,0	32,50
90D-35	M8	8,2	10,8	8,5	20,0	16,0	8,3	18,0	43,00
90D-50	M10	10,0	13,0	10,5	22,5	18,0	10,0	22,0	65,00
90D-70	M10	11,5	14,7	10,5	24,0	21,0	10,0	22,0	78,00
90D-95	M10	13,5	16,7	10,5	27,0	25,0	10,0	22,0	102,00
90D-120	M12	15,6	19,0	13,0	30,0	29,0	13,0	27,5	155,00
90D-150	M12	16,5	21,0	13,0	30,0	31,0	14,0	31,0	230,00
90D-185	M16	18,4	23,0	17,0	34,0	37,0	17,0	31,0	285,00
90D-240	M16	21,2	26,4	17,0	35,5	41,0	17,0	35,0	345,00

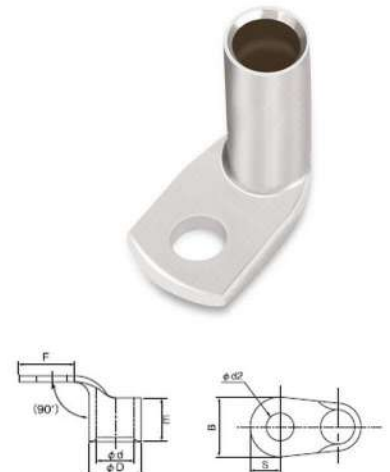

AKÜLÜ SKP SIKMA PENSELERİ



AKÜLÜ 3 SET'Lİ PENSE



Kablo Kesme (mm)
Kapasitesi 40



SKP Sıkma (mm²)
10-16-25-35-50-70-95-120-
150-185-240-300



Panç Delik Delme (mm)
22,5 - 28,3 - 36,6 -
43,2 - 49,6 - 61,5

ÜRÜN KODU

EB-60UNV

SIKMA KUVVETİ

60 KN

VOLTAJ

18 V.

ŞARJ SÜRESİ

2 SAAT

FİYAT (\$)

5500

ÜRÜNE DAHİL AKSESUAR:



1 Adet şarj aleti, 1 Adet pil

Çene takımı (10 - 300 mm² 12 Takım Çene)

Yedek Parça:



Yedek Pil / Şarj Aleti 2500 TL



Yedek Çene takımı 250 TL



AKÜLÜ SKP SIKMA PENSELERİ



AKÜLÜ 2 SET'Lİ PENSE



Kablo Kesme (mm)
Kapasitesi 40

SKP Sıkma (mm²)
10-16-25-35-50-70-95-120-
150-185-240-300

ÜRÜN KODU PZ-300 C

SIKMA KUVVETİ 60 KN

VOLTAJ 18 V.

ŞARJ SÜRESİ 2 SAAT

FİYAT (\$) 4000

ÜRÜNE DAHİL AKSESUAR:

- 1 Adet şarj aleti, 1 Adet pil
- Çene takımı (10 - 300 mm² 12 Takım Çene)

Yedek Parça:

- Yedek Pil / Şarj Aleti 1500 TL
- Yedek Çene takımı 250 TL



AKÜLÜ SKP SIKMA PENSELERİ



AKÜLÜ PABUÇ SIKMA PENSESİ

ÜRÜN KODU PZ-240

KAPASİTE (mm²) 10 - 240

SIKMA KUVVETİ 50 KN

VOLTAJ 18 V.

ŞARJ SÜRESİ 2 SAAT

FİYAT (\$) 3850

ÜRÜNE DAHİL AKSESUAR:

- 1 Adet şarj aleti, 1 Adet pil
- Çene takımı (10 - 240 mm² 11 Takım Çene)

Yedek Parça:

- Yedek Pil / Şarj Aleti 2500 TL
- Yedek Çene takımı 250 TL



AKÜLÜ PABUÇ SIKMA PENSESİ

ÜRÜN KODU EB-300

KAPASİTE (mm²) 10 - 300

SIKMA KUVVETİ 60 KN

VOLTAJ 18 V.

ŞARJ SÜRESİ 2 SAAT

FİYAT (\$) 4500

ÜRÜNE DAHİL AKSESUAR:

- 1 Adet şarj aleti, 1 Adet pil
- Çene takımı (10 - 300 mm² 12 Takım Çene)

Yedek Parça:

- Yedek Pil / Şarj Aleti 2500 TL
- Yedek Çene takımı 250 TL



AKÜLÜ SKP SIKMA PENSELERİ



AKÜLÜ PABUÇ SIKMA PENSESİ

ÜRÜN KODU	ED-630U
KAPASİTE (mm ²)	16 - 630
SIKMA KUVVETİ	130 KN
VOLTAJ	18 V.
ŞARJ SÜRESİ	2 SAAT
FİYAT (\$)	5500

ÜRÜNE DAHİL AKSESUAR:

- 1 Adet şarj aleti, 1 Adet pil
- Çene takımı (16 - 630 mm² 14 Takım Çene)

Yedek Parça:

- Yedek Pil / Şarj Aleti 2500 TL
- Yedek Çene takımı 250 TL



AKÜLÜ PABUÇ SIKMA PENSESİ

ÜRÜN KODU	ED-120UNV
KAPASİTE (mm ²)	10-300
SIKMA KUVVETİ	120 KN
VOLTAJ	18 V.
ŞARJ SÜRESİ	2 SAAT
FİYAT (\$)	5000

ÜRÜNE DAHİL AKSESUAR:

- 1 Adet şarj aleti, 1 Adet pil
- Çene takımı (10 - 400 mm² 13 Takım Çene)

Yedek Parça:

- Yedek Pil / Şarj Aleti 2500 TL
- Yedek Çene takımı 250 TL



AKÜLÜ SKP SIKMA PENSELERİ



AKÜLÜ PABUÇ SIKMA PENSESİ

ÜRÜN KODU	PZ - 300
KAPASİTE (mm ²)	10 - 300
SIKMA KUVVETİ	60 KN
VOLTAJ	18 V.
ŞARJ SÜRESİ	2 SAAT
FİYAT (\$)	3950

ÜRÜNE DAHİL AKSESUAR:

- 1 Adet şarj aleti, 1 Adet pil
- Çene takımı (10 - 300 mm² 12 Takım Çene)

Yedek Parça:

- Yedek Pil / Şarj Aleti 1500 TL
- Yedek Çene takımı 250 TL



AKÜLÜ PABUÇ SIKMA PENSESİ

ÜRÜN KODU	EB - 400
KAPASİTE (mm ²)	10 - 400
SIKMA KUVVETİ	120 KN
VOLTAJ	18 V.
ŞARJ SÜRESİ	2 SAAT
FİYAT (\$)	4900

ÜRÜNE DAHİL AKSESUAR:

- 1 Adet şarj aleti, 1 Adet pil
- Çene takımı (10 - 400 mm² 13 Takım Çene)

Yedek Parça:

- Yedek Pil / Şarj Aleti 1500 TL
- Yedek Çene takımı 250 TL



AKÜLÜ KABLO KESME MAKASLARI



AKÜLÜ KABLO KESME MAKASI



ÜRÜN KODU	EZ - 45	EZ - 85
KAPASİTE (mm ²)	Ø 45 3x120x70	Ø 85 3x240x120
SIKMA KUVVETİ	60 KN	60 KN
VOLTAJ	18 V.	18 V.
ŞARJ SÜRESİ	2 SAAT	2 SAAT
FİYAT (\$)	3300	3700

 Yedek Çene 150 \$

 Yedek Pil 2500 TL

AKÜLÜ KABLO KESME MAKASI

ÜRÜN KODU	EZ - 20
SIKMA KUVVETİ	50 KN
UZUNLUK (mm)	116x75x382
AĞIRLIK (Kg)	2.90
FİYAT (\$)	3100

 Yedek Çene 150 \$

 Yedek Pil 2500 TL

Çelik Halat	20 mm
Demir Çubuk	13 mm
Demir	14 mm
Bakır Tel	20 mm
Alüminyum Tel	20 mm
Zırlı Kablo	20 mm
Çelik Özlü Alüminyum iletkenler - ACSR	21 mm
Çelik Tel	20 mm



AKÜLÜ KABLO KESME MAKASLARI



AKÜLÜ KABLO KESME MAKASI

ÜRÜN KODU	EB-65C	EB-85C
KAPASİTE (mm ²)	Ø 65 3x150+95	Ø 85 3x240+120
SIKMA KUVVETİ	60 KN	60 KN
VOLTAJ	18 V.	18 V.
ŞARJ SÜRESİ	2 SAAT	2 SAAT
FİYAT (\$)	4300	4500



 Yedek Çene 150 \$

 Yedek Pil 1500 TL

AKÜLÜ KABLO KESME MAKASI

ÜRÜN KODU	EB-105C
KAPASİTE (mm ²)	Ø 105 3x300+185
SIKMA KUVVETİ	120 KN
VOLTAJ	18 V.
ŞARJ SÜRESİ	2 SAAT
FİYAT (\$)	4800



 Yedek Çene 150 \$

 Yedek Pil 1500 TL

HİDROLİK SKP SIKMA PENSELERİ

HİDROLİK PABUÇ SIKMA - KABLO KESME
PANÇ DELME 3'Ü BİR ARADA

ÜRÜN KODU HZ-60UNV

KAPASİTE (mm²) 16-300

SIKMA KUVVETİ 60 KN

UZUNLUK (mm) 540

AĞIRLIK (Kg) 3.5

FİYAT (\$) 1850

SKP Sıkma (mm²)
16-25-35-50-70-95-120-150-185-240-300Kablo Kesme (mm)
Kapasitesi 40Panç Delik Delme (mm)
22.5 - 28.3 - 36.6 - 43.2 - 49.6 - 61.5

Yedek Çene 80 TL

HİDROLİK PABUÇ SIKMA PENSESİ

ÜRÜN KODU HZ-300 HZ-400

KAPASİTE (mm²) 16 - 300 16 - 400

SIKMA KUVVETİ 60 KN 120 KN

UZUNLUK (mm) 460 540

AĞIRLIK (Kg) 3.3 6.3

FİYAT (\$) 1175 1400



ÜRÜNE DAHİL AKSESUAR:

 Çene takımı (10 - 400 mm² 13 Takım Çene)

Metal Çanta

HİDROLİK SKP SIKMA PENSELERİ

HİDROLİK PABUÇ SIKMA PENSESİ

ÜRÜN KODU **HZ-400U**KAPASİTE (mm²) 16 - 400

SIKMA KUVVETİ 120 KN

UZUNLUK (mm) 520

AĞIRLIK (Kg) 5.3

FİYAT (\$) 1400

ÜRÜNE DAHİL AKSESUAR:

 Çene takımı (10 - 400 mm² 13 Takım Çene)

 Metal Çanta

HİDROLİK PABUÇ SIKMA PENSESİ

ÜRÜN KODU **CYO-400C**KAPASİTE (mm²) 16 - 400

SIKMA KUVVETİ 126 KN

UZUNLUK (mm) 585

AĞIRLIK (Kg) 6.8

FİYAT (\$) 1200

 Çene takımı (16 - 400 mm² 13 Takım Çene)

 Metal Çanta

HİDROLİK PABUÇ SIKMA PENSESİ

ÜRÜN KODU **KDG-200**KAPASİTE (mm²) 16 - 200

SIKMA KUVVETİ 100 KN

AĞIRLIK (Kg) 4.8

FİYAT (\$) 580

HİDROLİK SKP SIKMA PENSELERİ

HİDROLİK PABUÇ SIKMA PENSESİ

ÜRÜN KODU	YQK-70	YYQ-120A
KAPASİTE (mm ²)	4 - 70	10 - 120
SIKMA KUVVETİ	45 KN	60 KN
UZUNLUK (mm)	310	425
AĞIRLIK (Kg)	1.8	4
FİYAT (\$)	140	160

 Yedek Çene 250 TL



HİDROLİK PABUÇ SIKMA PENSESİ

ÜRÜN KODU	YYQ-120	YQK-240	YQK-300
KAPASİTE (mm ²)	10 - 120	10 - 240	10 - 300
SIKMA KUVVETİ	60 KN	100 KN	100 KN
UZUNLUK (mm)	425	480	500
AĞIRLIK (Kg)	3.20	3.60	3.60
FİYAT (\$)	140	150	150

 Yedek Çene 250 TL



HİDROLİK PABUÇ SIKMA PENSESİ

ÜRÜN KODU	KYQ-300
KAPASİTE (mm ²)	16 - 300
SIKMA KUVVETİ	100 KN
UZUNLUK (mm)	500
AĞIRLIK (Kg)	4.60
FİYAT (\$)	580

 Yedek Çene 450 TL



PNOMATİK SIKMA PENSELERİ

KABLO PABUCU SIKMA PENSESİ

ÜRÜN KODU	AM-70
SIKMA KUVVETİ	2 TON
UZUNLUK (mm)	260x120x140
AĞIRLIK (Kg)	18.0
FİYAT (\$)	2500

KABLO PABUCU SIKMA PENSESİ

ÜRÜN KODU	AM-240
SIKMA KUVVETİ	8 TON
UZUNLUK (mm)	260x120x140
AĞIRLIK (Kg)	20.0
FİYAT (\$)	3000



HİDROLİK PABUÇ SIKMA PENSESİ

ÜRÜN KODU	KYQ-300 C
KAPASİTE (mm ²)	16 - 300
SIKMA KUVVETİ	100 KN
UZUNLUK (mm)	500
AĞIRLIK (Kg)	4.60
FİYAT (\$)	580

 Yedek Çene 450 TL



HİDROLİK MAKASLAR

ÜRÜN KODU	THC-20	Çelik Halat	20 mm
SIKMA KUVVETİ	60 KN	Demir Çubuk	13 mm
UZUNLUK (mm)	370	Demir	14 mm
AĞIRLIK (Kg)	2.90	Bakır Tel	20 mm
FİYAT (\$)	950	Alüminyum Tel	20 mm
		Zırhlı Kablo	20 mm
		Çelik Özlü Alüminyum İletkenler - ACSR	21 mm
		Çelik Tel	20 mm

 Yedek Çene 75 \$



HİDROLİK KABLO KESME MAKASI

ÜRÜN KODU	CPC-22A
KAPASİTE (mm ²)	Çelik Çubuk Φ 4 - Φ 22
SIKMA KUVVETİ	60 KN
AĞIRLIK (Kg)	4.80
FİYAT (\$)	230



Pnömatik Kablo Ucu Sıkma Pensesi

ÜRÜN KODU	UZUNLUK (mm)	AĞIRLIK (Kg)	HAVA BASINCI	FİYAT (\$)
AM-10	260 x 120 x 140	4.0	0.4 - 1 MPa	1000

AM = 10
PNÖMATİK SIKMA



HİDROLİK MAKASLAR

ÜRÜN KODU	CPC-40BL	CPC-40A
KAPASİTE (mm)	Çelik Tel Φ 28 ACSR Φ 40	Zırlı Kablo Φ 28 Telefon Kablo Φ 45
SIKMA KUVVETİ	60 KN	60 KN
AĞIRLIK (Kg)	5.60	5.60
FİYAT (\$)	900	450

 Yedek Çene 75 \$

 Metal Çanta



HİDROLİK KABLO KESME MAKASI

ÜRÜN KODU	CPC-50A
KAPASİTE (mm)	Telefon Kablo Φ 50 Zırlı Kablo Φ 45
SIKMA KUVVETİ	60 KN
AĞIRLIK (Kg)	7.10
FİYAT (\$)	520

 Yedek Çene 75 \$

 Metal Çanta



HİDROLİK KABLO KESME MAKASI

ÜRÜN KODU	HZ-45	HZ-85
KAPASİTE (mm ²)	Φ 45 3x120+70	Φ 85 3x240+120
SIKMA KUVVETİ	60 KN	60 KN
AĞIRLIK (Kg)	4.80	7.60
FİYAT (\$)	1200	1700

 Yedek Çene 150 \$

 Metal Çanta



HİDROLİK PANÇLAR

PANÇ DELME



ÜRÜN KODU

WK-8

KAPASİTE (mm²)

22.5 - 61.5

SIKMA KUVVETİ

70 KN

AĞIRLIK (Kg)

3.30

FİYAT (\$)

700

ÜRÜN KODU

TP-8C

KAPASİTE (mm²)

22.5 - 61.5

SIKMA KUVVETİ

66 KN

AĞIRLIK (Kg)

2.70

FİYAT (\$)

700



ÜRÜN KODU

SYK-8B

KAPASİTE (mm²)

22.5 - 61.5

SIKMA KUVVETİ

150 KN

FİYAT (\$)

750



KARE PATLATMA PANÇ

ÜRÜN KODU	DELİK ÇAP (mm)	DELME KALINLIĞI (mm)	FİYAT / ADET (\$)
PANÇ	15,9 X 15,9	3,5	150
PANÇ	19,1 X 19,1	3,5	180
PANÇ	32 X 32	3,5	300
PANÇ	45 X 45	3,5	430
PANÇ	68 X 68	3,5	650
PANÇ	92 X 92	3,5	830
PANÇ	104,8 X 104,8	3,5	900



ELEKTRİKLİ POMPALAR

ELEKTRİKLİ POMPA

ÜRÜN KODU	TEP - 700B
MOTOR VOLTAJI	AC 220V / 50HZ
Güç (Kw)	0.4
ÇIKIŞ BASINCI	0.23 L/dk - 1.3 L/Dk.
UZUNLUK (mm)	230X155X306
AĞIRLIK (Kg)	8.5
FİYAT (\$)	3000

 Metal Çanta



ELEKTRİKLİ POMPA

ÜRÜN KODU	ZCB6 - 6
MOTOR VOLTAJI	220V / 380V
Güç (Kw)	0.75
ÇIKIŞ BASINCI	0.5 L/dk - 5.0 L/Dk.
UZUNLUK (mm)	370X165X320
AĞIRLIK (Kg)	20.0
FİYAT (\$)	3500

 Metal Çanta



18V PİL İLE ÇALIŞAN TAŞINABİLİR POMPA

ÜRÜN KODU	EB-700
GÜÇ (W)	490 W
SIKMA KUVVETİ	700 Bar
PİL KAPASİTESİ	5.0 AH Li-ion 18V
AĞIRLIK (Kg)	5,9 KG
FİYAT (\$)	4200



HİDROLİK POMPALAR

HİDROLİK POMPA



ÜRÜN KODU CP - 390

ÇIKIŞ BASINCI 2 - 70 MPa

KAPASİTE (mm²) 16 - 300

UZUNLUK (mm) 400x105x155

AĞIRLIK (Kg) 7

FİYAT (\$) 1300

ÜRÜN KODU CP-700B



ÇIKIŞ BASINCI 2 - 70 MPa

UZUNLUK (mm) 510 x 150 x 200

AĞIRLIK (Kg) 12.5

FİYAT (\$) 750



 Yedek 2 mt. Hortum 35 \$  Metal Çanta

ÜRÜN KODU TFP-800



ÇIKIŞ BASINCI 2 - 70 MPa

UZUNLUK (mm) 540 x 150 x 200

AĞIRLIK (Kg) 9.0

FİYAT / ADET (\$) 930



 Yedek 2 mt. Hortum 35 \$  Metal Çanta

ÜRÜN KODU CFP-800

ÇIKIŞ BASINCI 2 - 70 MPa

UZUNLUK (mm) 540 x 150 x 200

AĞIRLIK (Kg) 8.0

FİYAT / ADET (\$) 850



 Yedek 2 mt. Hortum 35 \$

 Metal Çanta

HİDROLİK BARA DELME - KESME

HİDROLİK POMPA

ÜRÜN KODU CP-700AL

ÇIKIŞ BASINCI 2 - 70 MPa

UZUNLUK (mm) 510x140x150

AĞIRLIK (Kg) 9.0

FİYAT (\$) 680

Yedek 2 mt. Hortum 35 \$



BARA DELME KAFASI

ÜRÜN KODU CH - 60

ÇENELER Ø 10,5 - Ø 13,8 - Ø 17 - Ø 20,5

DELME KALINLIĞI 10

AĞIRLIK (Kg) 16.90

DELME KUVVETİ 300 KN

FİYAT (\$) 1200



BARA KESME KAFASI

ÜRÜN KODU CWC - 200

BARA KALINLIĞI (mm) 12

AĞIRLIK (Kg) 32.50

KESME KUVVETİ 200 KN

FİYAT (\$) 1200



BARA BÜKME KAFASI

ÜRÜN KODU CB - 150 D

BARA KALINLIĞI (mm) 10

AĞIRLIK (Kg) 19.20

EĞME KUVVETİ 160 KN

FİYAT (\$) 1280

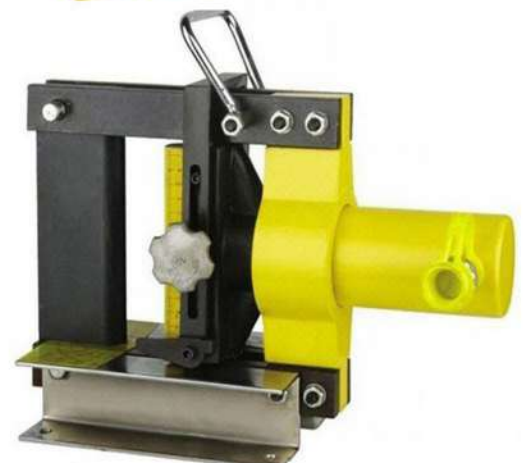

HİDROLİK PABUÇ SIKMA KAFALARI

HİDROLİK KAFALAR

ÜRÜN KODU SHP-430H

SIKMA KUVVETİ 120 KN

KAPASİTE (mm²) 50 - 400

AĞIRLIK (Kg) 3.90

FİYAT (\$) 730

Yedek Çene 350 TL

ÜRÜN KODU CO-400B

KAPASİTE (mm²) 16 - 400

SIKMA KUVVETİ 155 KN

AĞIRLIK (Kg) 6.5

FİYAT (\$) 640

Yedek Çene 350 TL

ÜRÜN KODU FHT-400U

SIKMA KUVVETİ 120 KN

KAPASİTE (mm²) 16 -400

AĞIRLIK (Kg) 3.90

FİYAT (\$) 700

Yedek Çene 350 TL

ÜRÜN KODU FYQ-630A

KAPASİTE (mm²) 150 - 630

SIKMA KUVVETİ 316 KN

AĞIRLIK (Kg) 15.4

FİYAT (\$) 1550

ÜRÜN KODU FYQ-1000

KAPASİTE (mm²) 400 - 1000

SIKMA KUVVETİ 495 KN

AĞIRLIK (Kg) 27,3

FİYAT (\$) 2750

Yedek Çene 500 TL



HİDROLİK KESME KAFALARI

HİDROLİK KAFALAR

ÜRÜN KODU	FHT-60UNV
KESME KUVVETİ	42 KN
UZUNLUK (mm)	540
AĞIRLIK (Kg)	3.50
FİYAT (\$)	1200



Papuç Sıkma: 16-25-35-50-70-95
120-150-185-240-300 mm²

Kablo Kesme Kapasitesi: 45 mm

Panç Delik Delme:
22.5-28.3-36.6-43.2-49.6-61.5 mm



ÜRÜN KODU	CPC-50B	CPC-65C
SIKMA KUVVETİ	60 KN	60 KN
UZUNLUK (mm)	340	340
AĞIRLIK (Kg)	6,2	6,2
FİYAT (\$)	620	900



ÜRÜN KODU	CPC-85C	CPC-105C
SIKMA KUVVETİ	60 KN	60 KN
UZUNLUK (mm)	370	370
AĞIRLIK (Kg)	6,7	7,2
FİYAT (\$)	1000	1300

 Yedek Çene 75 \$  Metal Çanta



ÜRÜN KODU	CPC-85B	CPC-100B
SIKMA KUVVETİ	60 KN	60 KN
UZUNLUK (mm)	465	515
AĞIRLIK (Kg)	7.90	8.40
FİYAT (\$)	950	1150

 Yedek Çene 150 \$

 Metal Çanta



CIRCIRLI KABLO KESME MAKASLARI

KESME MAKASLARI

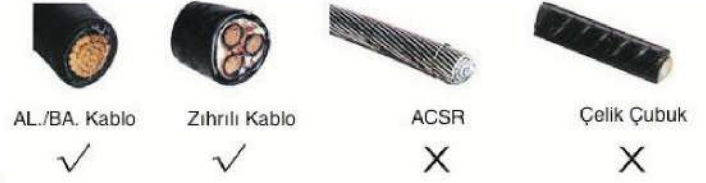
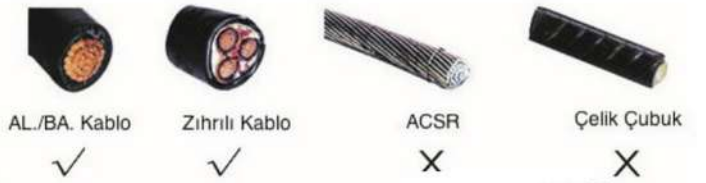
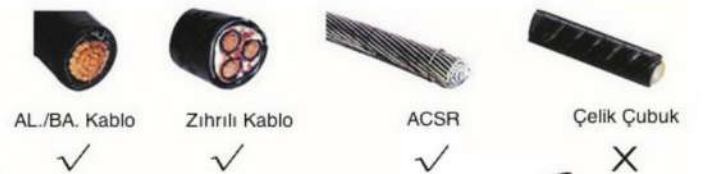
ÜRÜN KODU **TCR-101**KAPASİTE (mm) **Ø 90**UZUNLUK (mm) **480**AĞIRLIK (Kg) **6.5**FİYAT / ADET (\$) **800**ÜRÜN KODU **ZC-120A**KAPASİTE (mm) **Ø 120**UZUNLUK (mm) **555**AĞIRLIK (Kg) **7.0**FİYAT / ADET (\$) **900**ÜRÜN KODU **ZC-G40A**KAPASİTE (mm) **Çelik Zıhlı Kablo: Ø 20
Çekirdekli Kablo : Ø 36**UZUNLUK (mm) **440**AĞIRLIK (Kg) **3.6**FİYAT / ADET (\$) **580**ÜRÜN KODU **ZC-G32A**KAPASİTE (mm) **Çelik Tel : 100
Çelik Özlü Alüminyum : 600
Çelik Damarlı Kablo : 32**UZUNLUK (mm) **350**AĞIRLIK (Kg) **2.0**FİYAT / ADET (\$) **460**

MEKANİK PABUÇ SIKMA PENSELERİ

PABUÇ SIKMA PENSESİ

ÜRÜN KODU KH-230

KAPASİTE (mm²) 10 - 240

AĞIRLIK (Kg) 4

UZUNLUK (mm) 780

FİYAT / ADET (\$) 450



ÜRÜN KODU JT - 150

KAPASİTE (mm²) 10 - 150

AĞIRLIK (Kg) 4

FİYAT / ADET (\$) 400

 Yedek Çene 80 TL

 Plastik Çanta

ÜRÜN KODU JT-300

KAPASİTE (mm²) 16 - 300

AĞIRLIK (Kg) 4

FİYAT / ADET (\$) 560

 Yedek Çene 80 TL

 Plastik Çanta

ÜRÜN KODU JY-0650A JY-06120 JY-25150 JY-70240

KAPASİTE (mm²) 6 - 50 6 - 120 25 - 150 70 - 240

UZUNLUK (mm) 380 650 650 670

AĞIRLIK (Kg) 1.50 3.80 3.80 4.00

FİYAT (\$) 90 175 185 200



KABLO KESME MAKASLARI



ÜRÜN KODU	TCR-325	TCR-500S
KAPASİTE (mm)	36 - 300	60 - 500
UZUNLUK (mm)	260	320
AĞIRLIK (Kg)	0.60	0.80
FİYAT (\$)	225	340

ÜRÜN KODU	HS-125	LK-250	LK-500
KAPASİTE (mm ²)	125	240	500
UZUNLUK (mm)	320	600	780
AĞIRLIK (Kg)	0.7	1.8	2.8
FİYAT (\$)	70	135	200



ÜRÜN KODU	TC-125S	TC - 250 S
KAPASİTE (mm ²)	120	240
UZUNLUK (mm)	300	415
AĞIRLIK (Kg)	1.25	2.30
FİYAT (\$)	165	190



AKÜLÜ YÜKSÜK, İZOLE, PABUÇ SIKMA PENSESİ

ÜRÜN KODU	EX-50X
SIKMA KUVVETİ	16 KN
VOLTAJ	18 V.
ŞARJ SÜRESİ	2 SAAT
FİYAT (\$)	1400



YÜKSÜK SIKMA PENSELERİ

0.5-6 mm² Yüksük ve İzole Kablo Ucu Sıkma Pensesi

ÜRÜN KODU	FSB-056 GT
FİYAT (\$)	110

0.25-10 mm² Yüksük Sıkma Pensesi

ÜRÜN KODU	YAC-8
FİYAT (\$)	82

0.5-6 mm² Yüksük Sıkma Pensesi

ÜRÜN KODU	YAC-9
FİYAT (\$)	95

0.5-6 mm² Yüksük Sıkma Pensesi

ÜRÜN KODU	YYT B-4
FİYAT (\$)	65

6-16 mm² Yüksük Sıkma Pensesi

ÜRÜN KODU	YAC-6
FİYAT (\$)	65

0.5-6 mm² Çift Yüksük Sıkma Pensesi

ÜRÜN KODU	HS-26TW
FİYAT (\$)	65

25-50 mm² Yüksük Sıkma Pensesi

ÜRÜN KODU	AN-50WF
FİYAT (\$)	75

0.5-16 mm² Yüksük Sıkma Pensesi

ÜRÜN KODU	NWS-16
FİYAT (\$)	35

0.10-35 mm² Yüksük Sıkma Pensesi

ÜRÜN KODU	AN-35WF
FİYAT (\$)	76

4-16 mm² Yüksük Sıkma Pensesi

ÜRÜN KODU	HSC8 16-4
FİYAT (\$)	90



YÜKSÜK SIKMA PENSELERİ

0.5-2.5 mm² İzoleli Kablo Ucu Sıkma Pensesi

ÜRÜN KODU	YYT-1
FİYAT (\$)	60

0.5-6 mm² İzoleli Kablo Ucu Sıkma Pensesi

ÜRÜN KODU	YYT-7
FİYAT (\$)	65

0.08-2.5 mm² İzolesiz Terminal Sıkma Pensesi

ÜRÜN KODU	YYT-20
FİYAT (\$)	35

0.5-6 mm² İzolesiz Terminal Sıkma Pensesi

ÜRÜN KODU	YYT-11
FİYAT (\$)	65



0.5-10 mm Sıkmalı Kablo Pabucu Sıkma Pensesi

ÜRÜN KODU	AN-004
FİYAT (\$)	65

0.08-2.5 mm² İzolesiz Terminal Sıkma Pensesi

ÜRÜN KODU	HD-1102
FİYAT (\$)	65

0.5-2.5 mm² İzoleli Kablo Ucu Sıkma Pensesi

ÜRÜN KODU	YYT-22
FİYAT (\$)	30

35 mm² Kablo Kesme Makası

ÜRÜN KODU	DR-310A
FİYAT (\$)	30

0.5-6 mm² İzole Sıkma & Kablo Sıyırma

ÜRÜN KODU	HS-700S
FİYAT (\$)	38

0.5-6 mm² İzole Sıkma & Kablo Sıyırma

ÜRÜN KODU	HS-700C
FİYAT (\$)	28

PABUÇ SIKMA EL-PENSELERİ

6-50 mm² SKP Pabuç Sıkma Pensesi

ÜRÜN KODU

HD-50L

FİYAT (\$)

98

6-25 mm² SKP Pabuç Sıkma Pensesi

ÜRÜN KODU

MH-22

FİYAT (\$)

95

1.5-16 mm² SKP Pabuç Sıkma Pensesi

ÜRÜN KODU

T-16

FİYAT (\$)

85

1.5-10 mm² SKP Pabuç Sıkma Pensesi

ÜRÜN KODU

HD-10L

FİYAT (\$)

80

6-25 mm² SKP Pabuç Sıkma Pensesi

ÜRÜN KODU

HX-26B

FİYAT (\$)

90

0.5-10 mm² SKP Pabuç Sıkma Pensesi

ÜRÜN KODU

AN-005

FİYAT (\$)

73



BNC-YNC Konnektör Sıkma Pensesi

ÜRÜN KODU

AP-005H

FİYAT (\$)

73

1.5-06 mm² SKP Pabuç Sıkma Pensesi

ÜRÜN KODU

HD-10L

FİYAT (\$)

73

ÜRÜN KODU

T-007A

FİYAT (\$)

155

KAPASİTE (mm²)

0.5-10

0.5-10

0.5-6



TAKIM İÇERİĞİ

SIKMA KAPASİTE
(mm²)

AN-10

1.5 - 6

AN03B

1.0 - 4

AN-04WF

1.0 - 6

AN-16WF

6 - 16

AN-03C

0.5 - 6

FİYAT (\$)

165

KABLO SOYMA PENSELERİ



Φ15-Φ30 Kablo Soyma Pensesi

ÜRÜN KODU

SK-30

FİYAT (\$)

150



Φ15-Φ40 XLPE Sıyırma Pensesi

ÜRÜN KODU

BX-40

FİYAT (\$)

740

0.5-6mm² Kablo Sıyırma Pensesi

ÜRÜN KODU

HS-700B

FİYAT (\$)

40

4.6-20 mm² Metal Kablo Bağı
Sıkma Pensesi

ÜRÜN KODU

LQA-001

FİYAT (\$)

200



Φ15-Φ40 XLPE Sıyırma Pensesi

ÜRÜN KODU

SK-40

FİYAT (\$)

450

0.5-6mm² Kablo Sıyırma Pensesi

ÜRÜN KODU

HS-700D

FİYAT (\$)

28



6P/8P Girişli Konnektör Sıkma

ÜRÜN KODU

HT-86

FİYAT (\$)

38



4P/6P/8P Girişli Konnektör Sıkma

ÜRÜN KODU

HT-2008R

FİYAT (\$)

45

2.5-4.8 mm Kablo Bağı
Sıkma Pensesi

ÜRÜN KODU

HS-600

FİYAT (\$)

56

ISI İLE DARALAN MAKARON



KESİT mm	Daralmadan Sonra (mm)		RULO METRAJİ mt	FİYAT USD / MT		
	İÇ ÇAP	ET KALINLIK		SİYAH	SARI-YEŞİL	DİĞER RENKLER
1,5	0,85	0,32	200	0,097		
2,0	1,00	0,35	200	0,115		
2,5	1,30	0,38	200	0,150	0,420	0,170
3,0	1,50	0,40	200	0,160	0,430	
3,5	1,80	0,42	200	0,170		0,210
4,0	2,00	0,45	200	0,200		
4,5	2,30	0,50	100	0,230		
4,8	2,40	0,53	100	0,230	0,440	0,270
5,0	2,50	0,55	100	0,250		
6,0	3,00	0,55	100	0,290		
6,4	3,20	0,55	100	0,290	0,500	0,330
7,0	3,50	0,55	100	0,350		
8,0	4,00	0,60	100	0,350		
10,0	5,00	0,60	100	0,390	0,680	0,390
12,0	6,40	0,65	100	0,450		
12,7	6,40	0,65	100	0,450		
13,0	6,50	0,65	100	0,480	1,000	0,550
14,0	7,00	0,65	100	0,550		
16,0	8,00	0,70	100	0,750	1,450	0,850
18,0	9,00	0,80	100	0,980		
20,0	10,00	0,80	100	1,250	1,900	1,500
22,0	11,00	0,80	100	1,550		
25,0	12,50	0,90	50	1,650	2,750	1,900
30,0	15,00	0,95	50	2,150	3,700	2,400
35,0	17,50	1,00	50	2,700		
40,0	20,00	1,00	50	3,000	5,000	3,600
50,0	25,00	1,00	25	3,800	7,000	4,200
60,0	31,00	1,30	25	5,100	10,00	5,800
70,0	36,00	1,30	25	6,800		
80,0	41,00	1,46	25	7,500	15,00	8,000
90,0	46,00	1,46	25	8,500		
100,0	51,00	1,46	25	9,500	23,00	11,00
120,0	61,00	1,56	25	13,00		
150,0	76,00	1,56	25	19,00		
180,0	91,00	1,56	25	27,00		

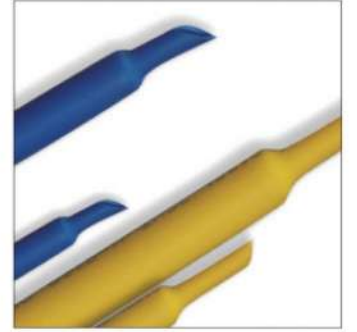

Özellikler

- Esnek
- Halojen Free - Alev Yürütmeyen
- Yanma Durumunda Düşük Duman
- Sürekli Çalışma Sıcaklığı : -45C - 125C arası
- Daralma Sıcaklığı : 125C
- 1/2 Oranında Daralma
- Voltaj Direnci : 600 V

KABLO PABUÇ SETLERİ

İZOLESİZ TERMİNAL SETLER

900 Adet Kablo Yüksüğü (0,5-0,75-1,0-1,5-2,5-4-6 mm2) + Yuvarlak & Çatal Tip Kablo Ucu + 6.3mm Dışı & Erkek & Yuvarlak Terminal + Çift Yüksük (0,5-1,0-1,5 mm2)

SET İÇERİĞİ

TKS-2.5-4 mm Yuvarlak Terminal (50 Adet)
6.3 mm Erkek Terminal (60 Adet)
6.3 mm Dışı Terminal (50 Adet)
0.5-1.5 mm M4 Yuvarlak Kablo Ucu (50 Adet)
6.0 mm Yüksük Yeşil (15 Adet)
1.5-2.5 mm M4 Çatal Kablo Ucu (50 Adet)
0.5 mm Çift Giriş Yüksük Beyaz (100 Adet)
1.5 mm Çift Giriş Yüksük Siyah (30 Adet)
1.0 mm Çift Giriş Yüksük Kırmızı (50 Adet)
1.5 mm Yüksük Siyah (60 Adet)
2.5 mm Yüksük Gri (35 Adet)
4.0 mm Yüksük Turuncu (20 Adet)
0.5 mm Yüksük Turuncu (150 Adet)
0.75 mm Yüksük Mavi (100 Adet)
1.0 mm Yüksük Kırmızı (85 Adet)

577 parça maasco ful-yarım izole ve izolesiz disi ve erkek kablo ucu pabuc terminal seti 0.5-6.0 mm2

SET İÇERİĞİ

1.5-2.5 Mavi Dışı (25 Adet)
1.5-2.5 Mavi Erkek (40 Adet)
1.5-2.5 Mavi Ful-dışı (17 Adet)
4.0-6.0 Sarı Dışı (20 Adet)
4.0-6.0 Sarı Erkek (28 Adet)
4.0-6.0 Sarı Ful-Dışı (14 Adet)
0.5-1.5 Kırmızı Dışı (35 Adet)
0.5-1.5 Kırmızı Erkek (50 Adet)
0.5-1.5 Kırmızı Ful-dışı (20 Adet)
6.3 Sarı Dışı Terminal (45 Adet)
6.3 Sarı Erkek Terminal (40 Adet)
2.8 Sarı Dışı Terminal (100 Adet)
2.8 Sarı Erkek Terminal (100 Adet)
6.3 Terminal Kılıfı (43 Adet)

340 Adet Yarım izoleli Dışı + Erkek İzolesiz Dışı + Erkek, İzoleli Ek-Muf 0,5-2.5 mm

SET İÇERİĞİ

1.5-2.5 mm2 Ek-Muf (25 Adet)
0.5-1.5 mm2 Ek-Muf (25 Adet)
0.5-1.5 mm2 Dışı 6.3mm (45 adet)
0.5-1.5 mm2 Erkek 6.3mm (55 adet)
1.5-2.5 mm2 Dışı 6.3mm (40 Adet)
1.5-2.5 mm2 Erkek 6.3mm (45 Adet)
İzolesiz dışı terminal 6.3mm (50 Adet)
İzolesiz Erkek terminal 6.3mm (60 Adet)
Plastik kılıf (19 Adet)

530 Adet Dışı + Erkek ve sarı topraklama terminal (Oto Tip Pabuç)

SET İÇERİĞİ

1. 50 Adet Sarı dışı Terminal 6.3 mm
2. 70 Adet Sarı Erkek Terminal 6.3 mm
3. 50 Adet Yuvarlak Tip Terminal
4. 90 Adet Sarı Terminal 4.8 mm
5. 100 Adet Sarı Terminal 2.8 mm
6. 140 Adet Sarı Terminal Erkek 2.8 mm
7. 50 Adet Şeffaf Kılıf

390 Adet Dışı + Erkek + Yuvarlak Tip izolesiz Sarı Terminal

SET İÇERİĞİ

100 Adet 6.3 mm Dışı Terminal
140 Adet 6.3 mm Erkek Terminal
100 Adet 2.5 mm Yuvarlak Terminal
+
50 Adet Terminal Kılıf

Maasco 365 adet Dışı Erkek yarım izoleli kablo ucu + izolesiz terminal kablo pabuç seti

SET İÇERİĞİ

4-6 mm2 Dışı 6.3mm (25 Adet)
4-6 mm2 Erkek 6.3mm (25 Adet)
0.5-1.5 mm2 Dışı 6.3mm (45 adet)
0.5-1.5 mm2 Erkek 6.3mm (55 adet)
1.5-2.5 mm2 Dışı 6.3mm (40 Adet)
1.5-2.5 mm2 Erkek 6.3mm (45 Adet)
İzolesiz dışı terminal 6.3mm (50 Adet)
İzolesiz Erkek terminal 6.3mm (60 Adet)
Plastik kılıf (19 Adet)

KABLO PABUÇ SETLERİ

İZOLESİZ TERMİNAL SETLER

İMALATIMIZ



336 Parça İzolesiz (Yuvarlak, Dışı, Erkek, Kılıf) Terminal Kablo Ucu Seti

SET İÇERİĞİ

- 10mm Topraklama (20 Adet)
- 8mm Topraklama (25 Adet)
- 6mm Topraklama (25 Adet)
- 4mm Topraklama (30 Adet)
- 2.5mm Topraklama (70 Adet)
- 6,3mm Dışı (35 Adet)
- 6,3mm Erkek (45 Adet)
- 4,8mm Dışı (70 Adet)
- 6,3 Şeffaf Kılıf (16 Adet)

300 parça Sarı Terminal Yuvarlak set (Oto Tip Pabuç) + Daralan Makaron 1-2,5 mm2

SET İÇERİĞİ

- M10 Topraklama (40 Adet)
- M8 Topraklama (40 Adet)
- M6 Topraklama (40 Adet)
- M5 Topraklama (40 Adet)
- M4 Topraklama (40 Adet)
- M3 Topraklama (100 Adet)

maasco 490 Parça izolesiz Sarı Terminal Fiş Seti (Dışı - Erkek - Geri Dönüşümlü - Eğri - Şeffaf Kılıf)

SET İÇERİĞİ

- 6,3mm dışı (1,5-2,5 mm2): 50 Adet
- 6,3mm için Şeffaf Kılıf: 35 Adet
- 9,5mm Dışı (4,0-6,0 mm2): 18 Adet
- 6,3mm Dışı Eğri 90Derece (1,5-2,5 mm2): 37 Adet
- 6,3mm Dışı + Erkek (Geri Dönüşümlü) (1,5-2,5 mm2): 28 Adet
- 6,3 mm Erkek (1,5-2,5 mm2): 75 Adet
- 4,8 mm Dışı (0,5-1,5 mm2): 100 Adet
- 2,8mm Dışı (0,5-1,5 mm2): 150 Adet

Maasco 74 parça lehimli daralanlı sıkı malı ek muf kablo birleştirici 0,5-6,0 mm2

SET İÇERİĞİ

- (0,5-1,5 mm2) Sıkı malı İzoleli 10 Adet
- (1,5-2,5 mm2) Sıkı malı İzoleli 10 Adet
- (4-6mm2) Sıkı malı İzoleli 10 Adet
- (0,5-1,5 mm2) Sıkı malı Daralanlı 10 Adet
- (1,5-2,5 mm2) Sıkı malı Daralanlı 7 Adet
- (4-6mm2) Sıkı malı Daralanlı 5 Adet
- (0,5-1,5 mm2) Lehimli Daralanlı 10 Adet
- (1,5-2,5 mm2) Lehimli Daralanlı 7 Adet
- (4-6mm2) Sıkı malı İzoleli 5 Adet

400 Adet kablo pabucu (izoleli kablo ucu Yuvarlak & Çatal + Terminal soket Dışı & Erkek)

SET İÇERİĞİ

- 0.5-1.5 Yuvarlak M4 (50 Adet)
- 1.5-2.5 Yuvarlak M4 (50 Adet)
- 4.0-6.0 Yuvarlak M4 (25 Adet)
- 0.5-1.5 Çatal M4 (50 Adet)
- 1.5-2.5 Çatal M4 (50 Adet)
- 4.0-6.0 Çatal M4 (25 Adet)
- 6.3 Dışı Soket (50 Adet)
- 6.3 Erkek Soket (50 Adet)
- 2.5 Yuvarlak Soket (50 Adet)

KABLO PABUÇ SETLERİ

İzoleli Kablo Yüksük Seti

315 adet maasco iğne tip & dışı faston Kablo Ucu Pabuç ve kablo birleştirici ek muf kablo pabucu setli kutulu



SET İÇERİĞİ

Ek-Muf Kırmızı (35 Adet)
Ek-Muf Mavi (31 Adet)
Ek-Muf Sarı (15 Adet)
Dışı Pabuç Kırmızı (45 Adet)
Dışı Pabuç Mavi (38 Adet)
Dışı Pabuç Sarı (27 Adet)
İğne tip Kırmızı (50 Adet)
İğne Tip Mavi (50 Adet)
İğne Tip Sarı (24 Adet)

İMALATIMIZ



126 Adet Şeffaf (Isı ile Daralanlı) Kablo Birleştirme Ek-Mufu 0,5-6 mm²



SET İÇERİĞİ

0.5-1.5 mm² Kırmızı (54 Adet)
1.5-2.5 mm² Mavi (45 Adet)
4.0-6.0 mm² Sarı (27 Adet)

290 Adet Yarı İzoleli Kablo Pabucu Seti (Dışı + Erkek, Yuvarlak + Çatal Tip)



SET İÇERİĞİ

0.5-1.5 mm² Erkek 6.3mm (20 Adet)
0.5-1.5 mm² Erkek 4.8mm (20 Adet)
4-6 mm² Dışı 6.3 mm (20 Adet)
0.5-1.5 mm² Dışı 4.8 mm (20 Adet)
0.5-1.5 mm² Dışı 6.3 mm (20 Adet)
4-6 mm² Erkek 6.3 mm (20 Adet)
1.5-2.5 mm² Erkek 6.3mm (20 Adet)
1.5-2.5 mm² Erkek 4.8mm (20 Adet)
1.5-2.5 mm² Yuvarlak M4 (20 Adet)
1.5-2.5 mm² Dışı 4.8 mm (20 Adet)
1.5-2.5 mm² Dışı 6.3 mm (20 Adet)
0.5-1.5 mm² Yuvarlak M4 (20 Adet)
1.5-2.5 mm² Çatal M4 (20 Adet)
0.5-1.5 mm² Çatal M4 (20 Adet)
4-6 mm² Yuvarlak M4 (10 Adet)

305 Parça Yarı İzoleli Dışı ve Erkek ve iğne Terminal Seti



SET İÇERİĞİ

4-6mm² Erkek Sarı 6.3 mm (20 Ad)
1.5mm² Erkek kırmızı 6.3mm (30 Ad)
2.5mm² Erkek Mavi 6.3mm (25 Ad)
1.5mm² Erkek Kırmızı 4.8mm (30 Ad)
4-6mm² Dışı Sarı 6.3 mm (20 Adet)
1.5mm² Dışı Kırmızı 6.3 mm (25 Ad)
2.5mm² Dışı Mavi 6.3mm (25 Adet)
1.5mm² Dışı Kırmızı 4.8mm (25 Adet)
2.5mm² Dışı Mavi 4.8mm (25 Adet)
2.5mm² Erkek Mavi 4.8mm (25 Ad)
1.5mm² İğne Tip Kırmızı (30 Adet)
2.5mm² İğne Tip Mavi (25 Adet)

maasco 274 Adet ek muf (kablo birleştirici) ve izoleli dışı - erkek faston terminal Pabuç kiti



SET İÇERİĞİ

25 Adet 0.5-1.5 mm² Dışı Faston
55 Adet 0.5-1.5 mm² Erkek Faston
18 Adet 0.5-1.5 mm² Dışı Faston
27 Adet 0.5-1.5 mm² Erkek Faston
20 Adet 0.5-1.5 mm² Erkek Faston
45 Adet 0.5-1.5 mm² Erkek Faston
0.5-6 mm² Kablo Birleştirici EKMUF 85 Adet

KABLO PABUÇ SETLERİ

İzoleli Kablo Yüksük Seti

490 Adet setli maasco Yuvarlak Yarım izoleli Kablo Ucu 0.5-6 mm²

SET İÇERİĞİ

- 0.5-1.5 Kırmızı M3 (50 Adet)
- 0.5-1.5 Kırmızı M4 (50 Adet)
- 0.5-1.5 Kırmızı M5 (50 Adet)
- 0.5-1.5 Kırmızı M6 (30 Adet)
- 0.5-1.5 Kırmızı M10 (30 Adet)
- 1.5-2.5 Mavi M3 (40 Adet)
- 1.5-2.5 Mavi M4 (40 Adet)
- 1.5-2.5 Mavi M5 (40 Adet)
- 1.5-2.5 Mavi M6 (30 Adet)
- 1.5-2.5 Mavi M8 (20 Adet)
- 4.0-6.0 Sarı M3 (20 Adet)
- 4.0-6.0 Sarı M4 (20 Adet)
- 4.0-6.0 Sarı M5 (20 Adet)
- 4.0-6.0 Sarı M6 (20 Adet)
- 4.0-6.0 Sarı M8 (20 Adet)

İMALATIMIZ



260 Adet maasco Çatal Tip Kablo Ucu Pabuç

SET İÇERİĞİ

- MCU 3001 (30 Adet)
- MCU 4001 (30 Adet)
- MCU 5001 (30 Adet)
- MCU 6001 (20 Adet)
- MCU 3002 (30 Adet)
- MCU 4002 (30 Adet)
- MCU 5002 (30 Adet)
- MCU 6002 (20 Adet)
- MCU 4006 (10 Adet)
- MCU 5006 (10 Adet)
- MCU 6006 (10 Adet)
- MCU 8006 (10 Adet)

412 Adet Dışı/Erkek Yarım ve Ful-izoleli Kablo Uçları 0.5-6 mm²

SET İÇERİĞİ

- 0.5-1.5 Erkek faston (40 Adet)
- 0.5-1.5 Dışı Faston (18 Adet)
- 4.0-6.0 Tam İzoleli Dışı (15 Adet)
- 1.5-2.5 Erkek Faston (40 Adet)
- 1.5-2.5 Dışı Faston (19 Adet)
- 1.5-2.5 Tam İzoleli Dışı (20 Adet)
- 4.0-6.0 Erkek Faston (23 Adet)
- 4.0-6.0 Dışı Faston (15 Adet)
- 0.5-1.5 Tam İzoleli Dışı (20 Adet)
- 1.5-2.5 Yarım İzoleli Dışı (32 Adet)
- 1.5-2.5 İzoleli Erkek (42 Adet)
- 0.5-1.5 Yarım İzoleli Dışı (35 Adet)
- 4.0-6.0 Yarım İzoleli Dışı (21 Adet)
- 4.0-6.0 İzoleli Erkek (27 Adet)
- 0.5-1.5 İzoleli Erkek (45 Adet)

74 Parça T-Soket kablo kesmeden hızlı ve kolay kablo ekleme parçası 0,5-6 mm²

SET İÇERİĞİ

- 0,5-1,5 mm² Kırmızı (Erkek + Klemens) (30 Adet)
- 1,5-2,5 mm² Mavi (Erkek + Klemens) (24 Adet)
- 4-6 mm² Sarı (Erkek + Klemens) (20 Adet)

maasco 240 Parça Dışı/Erkek + Ek-muf + Yuvarlak + Çatal izoleli Kablo ucu 0,5-6 mm²

SET İÇERİĞİ

- Tam İzoleli Dışı (4-6) (10 Adet)
- (4-6) Dışı + Erkek (20 Adet)
- M6 (4-6) Yuvarlak (10 Adet)
- İzoleli Ek-Muf (4-6) (10 Adet)
- M4 (0,5-1,5) Çatal (20 Adet)
- Tam İzoleli Dışı (1,5-2,5) (10 Adet)
- (1,5-2,5) Dışı + Erkek (20 Adet)
- M6 (1,5-2,5) Yuvarlak (15 Adet)
- İzoleli Ek-Muf (1,5-2,5) (15 Adet)
- M4 (0,5-1,5) Yuvarlak (20 Adet)
- Tam İzoleli Dışı (0,5-1,5) (10 Adet)
- (0,5-1,5) Dışı + Erkek (20 Adet)
- M6 (0,5-1,5) Yuvarlak (15 Adet)
- İzoleli Ek-Muf (0,5-1,5) (15 Adet)
- M4 (1,5-2,5) Yuvarlak (20 Adet)

maasco 120 Parça Dışı + Erkek + Tam izoleli dış faston izoleli Kablo Ucu 0,5-6 mm²

SET İÇERİĞİ

- 6,3mm (0,5-1,5) Erkek (10 Adet)
- 6,3mm (0,5-1,5) Dışı (10 Adet)
- 6,3mm (0,5-1,5) Ful İzole Dışı (10 Adet)
- 6,3mm (1,5-2,5) Erkek (10 Adet)
- 6,3mm (1,5-2,5) Dışı (10 Adet)
- 6,3mm (1,5-2,5) Ful İzole Dışı (10 Adet)
- 4,8mm (1,5-2,5) Erkek (10 Adet)
- 4,8mm (1,5-2,5) Dışı (10 Adet)
- 4,8mm (1,5-2,5) Mavi Ful İzole Dışı (10 Adet)
- 6,3mm (4-6) Erkek (10 Adet)
- 6,3mm (4-6) Dışı (10 Adet)
- 6,3mm (4-6) Ful İzole Dışı (10 Adet)

KABLO PABUÇ SETLERİ

Izoleli Kablo Yüksük Seti

1150 Adet Çift & Tek Girişli İzoleli Kablo Yüksüğü (0,5-0,75-1,0-1,5-2,5 mm²)

SET İÇERİĞİ

- 0.5 mm² Yüksüğü (200 Adet)
- 2x0.5 mm² yüksüğü (135 Adet)
- 0.75 mm² Yüksüğü (200 Adet)
- 1.0 mm² Yüksüğü (200 Adet)
- 2x1.0 mm² yüksüğü (90 Adet)
- 1.5 mm² Yüksüğü (120 Adet)
- 2x1.5 mm² Yüksüğü (60 Adet)
- 2.5 mm² yüksüğü (100 Adet)
- 2x2.5 mm² Yüksüğü (45 Adet)

İMALATIMIZ



1050 Adet kablo Yüksüğü (0,5-1,0-1,5-2,5 mm²), Yuvarlak & Çatal Tip pabucu, Dış & Yuvarlak Tip Açık terminal seti

SET İÇERİĞİ

- 0.5 mm² Yüksük (200 adet)
- 0.75 mm² Yüksük (200 adet)
- 1.0 mm² Yüksük (200 adet)
- 1.5 mm² Yüksük (150 adet)
- 2.5 mm² Yüksük (100 adet)
- 1,5-2,5 mm² Yuvarlak M5 (50 Adet)
- 1,5-2,5 mm² Çatal tip M5 (50 Adet)
- izolesiz terminal (50 adet)
- 6.3 mm dışı terminal (50 adet)

MAASCO 1200 Parça Kablo Pabucu Yüksük Seti
0.5-0,75-1-1,5-2,5-4-6-10 mm²

SET İÇERİĞİ

- 0.5 Yüksük: 250 ADET
- 0.75 Yüksük: 210 ADET
- 1.0 Yüksük: 210 ADET
- 1.5 Yüksük: 150 ADET
- 2.5 Yüksük: 100 ADET
- 4.0 Yüksük: 110 ADET
- 6.0 Yüksük: 75 ADET

1850 Parça İzoleli & İzolesiz Yüksük Seti
+ YYT-22 Sıkma Pensesi 0,5 - 2,5 mm²

SET İÇERİĞİ

- 0,5 mm İzoleli (90 Adet)
- 0,75 mm İzoleli (80 Adet)
- 1,0 mm İzoleli (100 Adet)
- 1,5 mm İzoleli (60 Adet)
- 2,5 mm İzoleli (40 Adet)
- 0,75 m İzolesiz (1000 Adet)
- 1,0 mm İzolesiz (200 Adet)
- 1,5 mm İzolesiz (200 Adet)
- 2,5 mm İzolesiz (100 Adet)

+
YYT-22 Sıkma Pensesi

248 Adet Sıkmalı Kablo Pabucu SKP + Sıkmalı Ek Muf + Isı ile Daralan Makaron Seti

SET İÇERİĞİ

- SKP 16-M6 (20 Adet)
- SKP 16-M8 (20 Adet)
- SKP 10-M5 (25 Adet)
- SKP 10-M8 (20 Adet)
- SKP 25-M8 (12 Adet)
- SKP 25-M10 (12 Adet)
- 10mm Ek-Muf (54Adet)
- 16mm Ek-Muf (12Adet)

- 8.0 mm Daralan x 40 mm x 25 Adet
- 10.0 mm Daralan x 40 mm x 25 Adet

KABLO PABUÇ SETLERİ

Izoleli Kablo Yüksük Seti

MAASCO 1000 Parça Kablo Pabucu Yüksük Seti
0.5-0,75-1-1,5-2,5-4-6-10 mm²

SET İÇERİĞİ

- 0.5 Yüksük: **250 ADET**
- 0.75 Yüksük: **210 ADET**
- 1.0 Yüksük: **210 ADET**
- 1.5 Yüksük: **150 ADET**
- 2.5 Yüksük: **100 ADET**
- 4.0 Yüksük: **35 ADET**
- 6.0 Yüksük: **25 ADET**
- 10.0 Yüksük: **40 ADET**

İMALATIMIZ

YERLİ
ÜRETİM

MAASCO 1650 Parça kablo numaratorü
Kablo kodlama numaraları (0-9)

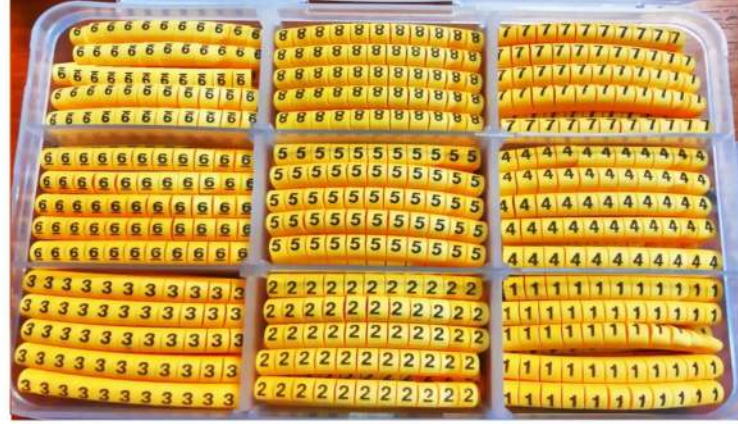

510 Adet maasco izoleli kablo Yüksük Seti
(0,5-1,0-1,5-2,5-4,0-6,0-10-16-25)

SET İÇERİĞİ

- 0,5 Yüksük Turuncu (75 Adet)
- 1,0 Yüksük Kırmızı (75 Adet)
- 1,5 Yüksük Siyah (75 Adet)
- 2,5 Yüksük Gri (40 Adet)
- 4,0 Yüksük Turuncu (40 Adet)
- 6,0 Yüksük Yeşil (20 Adet)
- 10,0 Yüksük Kahve (15 Adet)
- 16,0 Yüksük Bej (10 Adet)
- 25,0 Yüksük Siyah (10 Adet)

72 Adet Sıkmalı Bakir (Kalay Kaplı)
SKP Kablo Pabucu, Akü Başı

SET İÇERİĞİ

- 10-M6 (20 Adet)
- 16-M6 (20 Adet)
- 25-M8 (10 Adet)
- 35-M8 (10 Adet)
- 50-M10 (6 Adet)
- 70-M10 (6 Adet)

MAASCO 600 parça izolesiz yüksük seti (0,5-6 mm²)

SET İÇERİĞİ

- 0,5 izolesiz : **100 Adet**
- 0.75 Izolesiz : **100 adet**
- 1.0 Izolesiz : **100 adet**
- 1.5 Izolesiz : **100 adet**
- 2.5 Izolesiz : **100 adet**
- 4,0 izolesiz : **50 Adet**
- 6,0 İzolesiz : **50 Adet**

204 Adet Sıkmalı Kablo Pabucu SKP + Isı ile Daralan Makaron Seti

SET İÇERİĞİ

- SKP 16-M6 (20 Adet)
- SKP 16-M8 (20 Adet)
- SKP 10-M5 (25 Adet)
- SKP 10-M8 (20 Adet)
- SKP 25-M8 (12 Adet)
- SKP 25-M10 (12 Adet)
- SKP 35-M8 (10 Adet)
- SKP 35-M10 (10 Adet)

- 8.0 mm Daralan x 40 mm x 25 Adet
- 10.0 mm Daralan x 40 mm x 25 Adet

İZOLELİ KABLO YÜKSÜKLERİ
FRANSIZ NORMU (DIN 46228)



ÜRÜN KODU	KABLO KESİTİ (mm ²)	RENK		EBATLAR (mm)					AMBALAJ MİKTARI (KUTU)	FİYAT (TL / ADET)
		ALMAN	FRANSIZ	F	L	W	B	D		
MIY-0.5-8	0.50			8	14	2,6	6,0	1,3	1.000	0,24
MIY-0.75-8	0.75			8	14	2,8	6,3	1,5	1.000	0,24
MIY-1.0-8	1.00			8	14	3,0	6,3	1,7	1.000	0,24
MIY-1.5-8	1.50			8	14	3,5	6,3	2,0	1.000	0,26
MIY-1.5-10	1.50			10	16	3,5	6,3	2,0	500	0,30
MIY-2.5-8	2.50			8	14	4,2	7,4	2,5	500	0,35
MIY-2.5-12	2.50			12	18	4,2	7,4	2,5	500	0,40
MIY-4.0-10	4.00			10	17	4,8	7,4	3,2	500	0,60
MIY-6.0-12	6.00			12	20	6,3	8,5	3,9	250	0,80
MIY-10-12	10.00			12	22	7,6	8,8	4,9	100	1,00
MIY-16-12	16.00			12	24	8,8	10,0	6,2	100	1,40
MIY-25-16	25.00			16	28	11,2	12,0	7,7	50	2,35
MIY-35-16	35.00			16	30	12,7	14,0	8,7	50	3,15
MIY-50-20	50.00			20	36	15,0	16,0	10,9	25	6,00
MIY-70-21	70.00			21	37	16,0	17,0	14,3	25	11,00

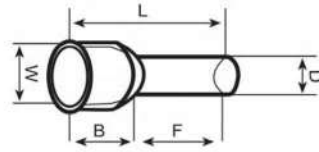

İZOLELİ ÇİFT GİRİŞLİ KABLO YÜKSÜKLERİ
FRANSIZ NORMU (DIN 46228)



ÜRÜN KODU	KABLO KESİTİ (mm ²)	RENK	EBATLAR (mm)					AMBALAJ MİKTARI (KUTU)	FİYAT (TL / ADET)
			F	L	W	B	D		
MCY-0.5-8	0.50		8	14	5,0	6,5	1,8	1.000	0,60
MCY-0.75-8	0.75		8	14	5,5	6,7	2,1	500	0,65
MCY-1.0-8	1.00		8	14	5,5	7,1	2,4	500	0,70
MCY-1.5-8	1.50		8	14	6,4	7,5	2,6	500	0,80
MCY-2.5-10	2.50		10	18	8,0	8,5	3,3	250	1,25
MCY-4.0-12	4.00		12	23	8,0	11,1	4,2	200	1,55
MCY-6.0-14	6.00		14	26	9,5	12,1	5,3	100	1,75
MCY-10-14	10.00		14	27	12,6	12,6	6,9	100	2,75
MCY-16-14	16.00		14	31	19,0	17,3	8,7	50	3,50

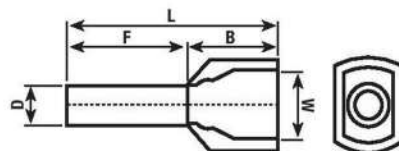

YUVARLAK TIP İZOLELİ KABLO UÇLARI

FRANSIZ NORMU (DIN 46237)



ÜRÜN KODU	KABLO KESİTİ (mm ²)	ÇİVATA ÖLÇÜSÜ	EBATLAR (mm)					AMBALAJ MİKTARI (KUTU)	FİYAT (TL / ADET)	
			E	L	B	D	W		RENK	FIYAT
MYU-301	0,50 - 1,50	M3	3,2	17,3	10,4	4,0	6,0	200	■	0,95
MYU-351		M3,5	3,7	17,3	10,4	4,0	6,0	200	■	1,25
MYU-401		M4	4,3	21,8	10,4	4,0	8,0	200	■	1,30
MYU-501		M5	5,3	21,8	10,4	4,0	8,0	200	■	1,35
MYU-601		M6	6,4	27,5	10,4	4,0	11,6	200	■	2,00
MYU-801		M8	8,4	27,5	10,4	4,0	11,6	200	■	2,10
MYU-1001		M10	10,5	31,8	10,4	4,0	13,6	200	■	2,55
MYU-1201		M12	13,5	31,8	10,4	4,0	13,6	200	■	3,55
MYU-302	1,50 - 2,50	M3	3,2	22,3	10,4	4,6	8,5	200	■	1,65
MYU-352		M3,5	3,7	22,3	10,4	4,6	8,5	200	■	1,65
MYU-402		M4	4,3	22,3	10,4	4,6	8,5	200	■	1,65
MYU-502		M5	5,3	22,3	10,4	4,6	9,5	200	■	1,70
MYU-602		M6	6,4	27,3	10,4	4,6	12,0	200	■	2,25
MYU-802		M8	8,4	27,3	10,4	4,6	12,0	200	■	2,35
MYU-1002		M10	10,5	30,8	10,4	4,6	13,6	200	■	2,50
MYU-1202		M12	13,5	30,8	10,4	4,6	13,6	200	■	3,15
MYU-306	4,00 - 6,00	M3	3,7	26,5	13,5	6,6	9,5	100	■	3,35
MYU-406		M4	4,3	26,5	13,5	6,6	9,5	100	■	3,65
MYU-506		M5	5,3	26,5	13,5	6,6	9,5	100	■	3,65
MYU-606		M6	6,4	29,2	13,5	6,6	12,0	100	■	4,10
MYU-806		M8	8,4	34,5	13,5	6,6	15,0	100	■	5,10
MYU-1006		M10	10,5	34,5	13,5	6,6	15,0	100	■	5,40
MYU-1206	M12	13,5	34,5	13,5	6,6	15,0	100	■	5,80	
MYU-510	6,0 - 10,0	M5	5,3	30,0	17,5	8,3	10,0	100	■	6,00
MYU-610		M6	6,4	31,5	17,5	8,3	11,0	100	■	6,25
MYU-810		M8	8,4	36,0	17,5	8,3	14,0	100	■	6,80
MYU-1010		M10	10,5	39,0	17,5	8,3	18,0	100	■	7,15
MYU-516	10,0 - 16,0	M5	5,3	37,5	23,0	9,7	11,0	50	■	7,80
MYU-616		M6	6,4	37,5	23,0	9,7	11,0	50	■	8,25
MYU-816		M8	8,4	43,0	23,0	9,7	14,0	50	■	8,50
MYU-1016		M10	10,5	45,0	23,0	9,7	18,0	50	■	9,20
MYU-1216		M12	13,0	45,0	23,0	9,7	18,0	50	■	9,75

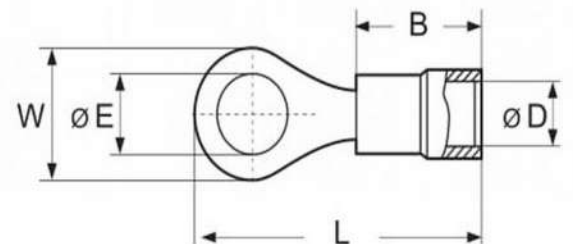

ÇATAL TIP İZOLELİ KABLO UÇLARI
FRANSIZ NORMU (DIN 46237)



ÜRÜN KODU	KABLO KESİTİ (mm ²)	CİVATA ÖLÇÜSÜ	EBATLAR (mm)					AMBALAJ MİKTARI (KUTU)	FİYAT (TL / ADET)	
			E	L	B	D	W		RENK	FIYAT
MCU-3001	0,50 - 1,50	M3	3,2	21,8	10,4	4,0	5,7	200	■	1,15
MCU-3501		M3,5	3,7	21,8	10,4	4,0	5,7	200	■	1,20
MCU-4001		M4	4,3	21,8	10,4	4,0	6,4	200	■	1,20
MCU-5001		M5	5,3	21,8	10,4	4,0	8,0	200	■	1,25
MCU-6001		M6	6,7	21,8	10,4	4,0	10,7	200	■	1,40
MCU-8001		M8	5,3	21,8	10,4	4,0	8,0	200	■	1,95
MCU-1001		M10	6,7	21,8	10,4	4,0	10,7	200	■	2,25
MCU-3002	1,50 - 2,50	M3	3,2	21,8	10,4	4,6	5,7	200	■	1,50
MCU-3502		M3,5	3,7	21,8	10,4	4,6	5,7	200	■	1,55
MCU-4002		M4	4,3	21,8	10,4	4,6	6,4	200	■	1,55
MCU-5002		M5	5,3	21,8	10,4	4,6	8,0	200	■	1,60
MCU-6002		M6	6,7	24,8	10,4	4,6	10,7	200	■	2,20
MCU-8002		M8	6,7	24,8	10,4	4,6	10,7	200	■	2,25
MCU-1002		M10	6,7	24,8	10,4	4,6	10,7	200	■	2,35
MCU-4006	4,00 - 6,00	M4	4,3	26,5	13,5	6,6	8,2	100	■	3,35
MCU-5006		M5	5,3	26,5	13,5	6,6	9,0	100	■	3,35
MCU-6006		M6	6,7	31,2	13,5	6,6	12,0	100	■	3,85
MCU-6008		M8	6,7	31,2	13,5	6,6	12,0	100	■	4,75
MCU-6010		M10	6,7	31,2	13,5	6,6	12,0	100	■	4,75
MCU-5010	6,0 - 10,0	M5	5,3	29,5	17,5	8,3	9,0	100	■	6,25
MCU-6010		M6	6,7	32,0	17,5	8,3	12,0	100	■	6,85
MCU-5016	10,0 - 16,0	M5	5,3	40,5	23,0	9,7	12,0	50	■	8,90
MCU-6016		M6	6,7	40,5	23,0	9,7	12,0	50	■	9,65

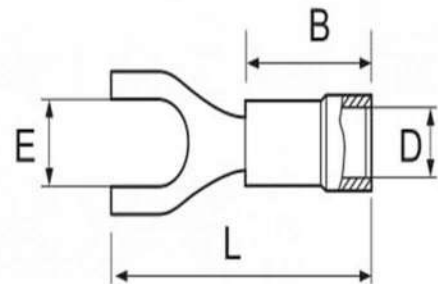

EK MUF İZOLELİ KABLO UÇLARI
FRANSIZ NORMU (DIN 46237)



ÜRÜN KODU	KABLO KESİTİ (mm ²)	EBATLAR (mm)			AMBALAJ MİKTARI (KUTU)	FİYAT (TL / ADET)	
		L	D	d		RENK	FIYAT
MBY-251	0,5-1,5	23,0	4,0	2,0	200		2,00
MBY-252	1,5-2,5	23,2	4,5	2,4	200		2,15
MBY-256	4,0-6,0	25,5	6,3	3,6	100		3,50
MBY-2510	6,0-10,0	35,8	8,5	5,1	50		4,90

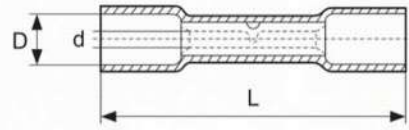

ISI BÜZÜŞMELİ EK MUF KABLO UÇLARI
FRANSIZ NORMU (DIN 46237)



ÜRÜN KODU	KABLO KESİTİ (mm ²)	EBATLAR (mm)			AMBALAJ MİKTARI (KUTU)	FİYAT (TL / ADET)	
		L	D	d		RENK	FIYAT
MPY-251	0,5-1,5	38,0	4,0	2,0	200		9,50
MPY-252	1,5-2,5	38,0	4,5	2,4	200		11,50
MPY-256	4,0-6,0	42,0	6,3	3,6	100		13,00

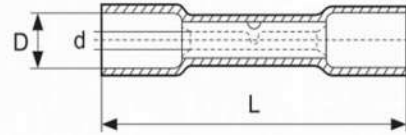

LEHİMLİ DARALANLI EK-MUF
FRANSIZ NORMU (DIN 46237)

ÜRÜN KODU	KABLO KESİTİ (mm ²)	EBATLAR (mm)			AMBALAJ MİKTARI (KUTU)	FİYAT (TL / ADET)	
		L	D	d		RENK	FIYAT
MPPY-250	0,25-0,34	23,0	4,0	2,0	200		6,00
MPPY-251	0,5-1,5	23,2	4,5	2,4	200		7,75
MPPY-252	1,5-2,5	25,5	6,3	3,6	100		9,00
MPPY-256	4,0-6,0	35,8	8,5	5,1	50		10,50

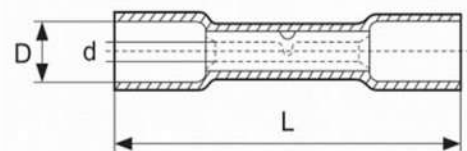

ERKEK FASTON TİP TERMINALLER

FRANSIZ NORMU (DIN 46237)

ÜRÜN KODU	KABLO KESİTİ (mm ²)	SOKET GENİŞLİĞİ	EBATLAR (mm)					AMBALAJ MIKTARI (KUTU)	FİYAT (TL / ADET)	
			L	B	W	D	d		RENK	FIYAT
MFE-1288	0,50 – 1,50	0,8 X 2,8	17,7	10,0	2,8	4,3	1,7	200	■	1,00
MFE-1488		0,8 X 4,75	18,5	10,0	4,75	4,3	1,7	200	■	1,25
MFE-1638		0,8 X 6,35	21,0	10,0	6,35	4,3	1,7	200	■	1,45
MFE-2488	1,50 – 2,50	0,8 X 4,75	18,5	10,0	4,75	4,7	2,3	200	■	1,35
MFE-2638		0,8 X 6,35	21,0	10,0	6,35	4,7	2,3	200	■	1,60
MFE5638	4,00 – 6,00	0,8 X 6,35	25,0	14,0	6,35	5,75	3,4	100	■	1,90

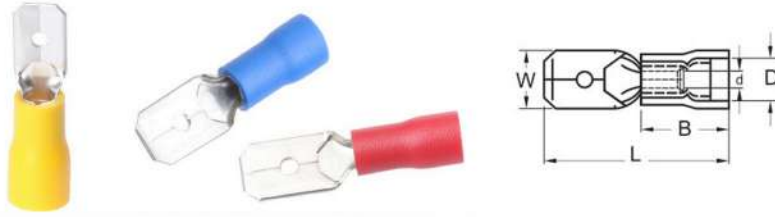

DIŞI FASTON TİP TERMINALLER

FRANSIZ NORMU (DIN 46237)

ÜRÜN KODU	KABLO KESİTİ (mm ²)	SOKET GENİŞLİĞİ	EBATLAR (mm)					AMBALAJ MIKTARI (KUTU)	FİYAT (TL / ADET)	
			L	B	W	D	d		RENK	FIYAT
MFD-1288	0,50 – 1,50	0,8 X 2,8	19,0	10,0	3,8	3,8	1,7	200	■	0,90
MFD-1488		0,8 X 4,75	19,0	10,0	5,6	3,8	1,7	200	■	1,20
MFD-1638		0,8 X 6,35	21,0	10,0	7,4	3,8	1,7	200	■	1,50
MFD-2288	1,50 – 2,50	0,8 X 2,8	19,0	10,0	3,8	4,3	2,3	200	■	1,20
MFD-2488		0,8 X 4,75	19,0	10,0	5,6	4,3	2,3	200	■	1,35
MFD-2638		0,8 X 6,35	21,0	10,0	7,4	4,3	2,3	200	■	1,55
MFD-5638	4,00 – 6,00	0,8 X 6,35	25,0	14,0	7,4	5,7	3,4	100	■	1,85



POLYAMİD DIŞI FASTON TİP KABLO UÇLARI

FRANSIZ NORMU (DIN 46237)

ÜRÜN KODU	KABLO KESİTİ (mm ²)	SOKET GENİŞLİĞİ	EBATLAR (mm)					AMBALAJ MIKTARI (KUTU)	FİYAT (TL / ADET)	
			L	B	W	D	d		RENK	FIYAT
MPFD-1638	0,50 – 1,50	0,8 X 6,35	22,0	11,0	6,6	4,0	1,7	200	■	4,50
MPFD-2638	1,50 – 2,50	0,8 X 6,35	22,0	11,0	6,6	5,0	2,3	200	■	5,20
MPFD-5638	4,00 – 6,00	0,8 X 6,35	24,0	13,0	6,6	6,3	3,4	100	■	5,90



TAM İZOLELİ DİŞİ FASTON TİP KABLO UÇLARI
FRANSIZ NORMU (DIN 46237)

ÜRÜN KODU	KABLO KESİTİ (mm ²)	SOKET GENİŞLİĞİ	EBATLAR (mm)					AMBALAJ MİKTARI (KUTU)	FİYAT (TL / ADET)	
			L	B	W	D	d		RENK	FIYAT
MFFD-1288	0,50 - 1,50	0,8 X 2,80	19,0	5,0	3,2	4,0	1,7	200	■	1,80
MFFD-1488		0,8 X 4,75	20,0	5,0	5,6	4,0	1,7	200	■	1,90
MFFD-1638		0,8 X 6,35	21,5	6,6	7,4	4,0	1,7	200	■	2,15
MFFD-2288	1,50 - 2,50	0,8 X 2,80	19,0	5,0	3,2	4,5	2,3	200	■	1,80
MFFD-2488		0,8 X 4,75	20,0	5,0	5,6	4,5	2,3	200	■	1,90
MFFD-2638		0,8 X 6,35	21,5	6,6	7,4	4,5	2,3	200	■	2,15
MFFD-5638		4,00 - 6,00	0,8 X 6,35	25,5	6,6	7,4	5,7	3,4	100	■

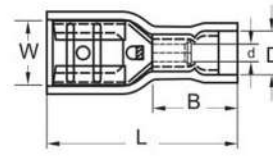

İZOLESİZ TERMİNAL KABLO UCU



ÜRÜN KODU	1 D
AÇIKLAMA	6,3mm Dışı
ADET	300 Adet
FİYAT	1,25



ÜRÜN KODU	2 D
AÇIKLAMA	Tırnaklı Dışı
ADET	300 Adet
FİYAT	1,25



ÜRÜN KODU	1d Mini
AÇIKLAMA	4,8mm Dışı
ADET	500 Adet
FİYAT	0,98



ÜRÜN KODU	1/2 D
AÇIKLAMA	2,8mm Dışı
ADET	1000 Adet
FİYAT	0,80



ÜRÜN KODU	1D Eğri
AÇIKLAMA	90 Derece Dışı
ADET	250 Adet
FİYAT	1,65



ÜRÜN KODU	1-DE
AÇIKLAMA	Geri-Dönüşümlü
ADET	200 Adet
FİYAT	3,10



ÜRÜN KODU	1-eçk
AÇIKLAMA	6,3mm Dışı
ADET	400 Adet
FİYAT	1,25



ÜRÜN KODU	1/2-EU
AÇIKLAMA	2,8mm Erkek
ADET	1000 Adet
FİYAT	1,15



ÜRÜN KODU	3D
AÇIKLAMA	7,8mm Dışı
ADET	150 Adet
FİYAT	3,70



ÜRÜN KODU	2,5-M4
AÇIKLAMA	2,5-M4
ADET	500 Adet
FİYAT	1,25



ÜRÜN KODU	2,5-M5
AÇIKLAMA	2,5-M5
ADET	500 Adet
FİYAT	1,25



ÜRÜN KODU	4-4
AÇIKLAMA	M4 Topraklama
ADET	500 Adet
FİYAT	1,25



ÜRÜN KODU	6-6
AÇIKLAMA	M6 Yuvarlak
ADET	150 Adet
FİYAT	3,55



ÜRÜN KODU	8-8
AÇIKLAMA	M8 Yuvarlak
ADET	150 Adet
FİYAT	3,75



ÜRÜN KODU	10-10
AÇIKLAMA	M10 Yuvarlak
ADET	100 Adet
FİYAT	4,00



ÜRÜN KODU	1D Kılıf
AÇIKLAMA	6,3mm Kılıf
ADET	300 Adet
FİYAT	0,65

ÜRÜN KODU	KABLO KESİTİ (mm ²)	EBATLAR (mm)			AMBALAJ MİKTARI (KUTU)	FİYAT (TL / ADET)	
		L	C	D		RENK	FİYAT
MAS-2IB	0,14 - 4,0	12,20	20,70	14,50	100	9,00	
MAS-3IB	0,14 - 4,0	16,80	20,70	14,50	100	11,50	
MAS-5IB	0,14 - 4,0	26,00	20,70	14,50	50	15,00	

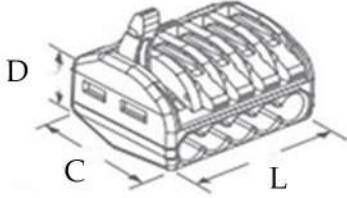

ÜRÜN KODU	KABLO KESİTİ (mm ²)	EBATLAR (mm)			AMBALAJ MİKTARI (KUTU)	FİYAT (TL / ADET)	
		W	H	L		RENK	FİYAT
MAS-SP1	0,5-1,5	20,00	8,00	25,0	200	2,50	
MAS-SP2	1,5-2,5	20,00	8,00	25,0	200	3,00	
MAS-SP3	4,0-6,0	20,00	11,00	35,0	100	4,25	



POLYAMİD DİŞİ FASTON TİP KABLO UÇLARI FRANSIZ NORMU (DIN 46237)

ÜRÜN KODU	KABLO KESİTİ (mm ²)	SOKET GENİŞLİĞİ	EBATLAR (mm)					AMBALAJ MİKTARI (KUTU)	FİYAT (TL / ADET)	
			L	B	W	D	d		RENK	FİYAT
MAS-SP1A	0,50 - 1,50	0,8 X 6,35	22,0	11,0	6,6	4,0	1,7	200	4,00	
MAS-SP2A	1,50 - 2,50	0,8 X 6,35	22,0	11,0	6,6	5,0	2,3	200	5,00	
MAS-SP3A	4,00 - 6,00	0,8 X 6,35	24,0	13,0	6,6	6,3	3,4	100	6,00	



ERKEK / DIŐI TIP GERİ DÖNÜŐLÜ TERMİNALLER

FRANSIZ NORMU (DIN 46237)



ÜRÜN KODU	KABLO KESİTİ (mm ²)	SOKET GENİŐLİĐİ	EBATLAR (mm)					AMBALAJ MIKTARI (KUTU)	FİYAT (TL / ADET)	
			L	B	W	D	d			
MFDEG-1861	0,50 – 1,50	0,8 X 6,35	22,0	10,5	6,8	3,8	1,7	200		2,95
MFDEG-2862	1,50 – 2,50	0,8 X 6,35	22,0	10,5	6,8	4,3	2,3	200		3,10
MFDEG-5866	4,00 – 6,00	0,8 X 6,35	25,0	14,0	6,8	5,7	3,4	100		3,45

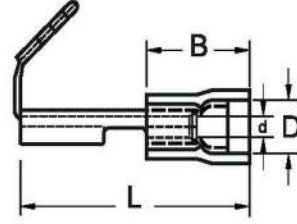

ERKEK TERMİNAL İZOLELİ KABLO UÇLARI

FRANSIZ NORMU (DIN 46237)



ÜRÜN KODU	KABLO KESİTİ (mm ²)	EBATLAR (mm)				AMBALAJ MIKTARI (KUTU)	FİYAT (TL / ADET)	
		L	B	D	d			
MBE-1040	0,5-1,5	20,4	9,8	3,5	4,0	200		3,00
MBE-2040	1,5-2,5	20,4	9,8	4,2	4,0	200		3,25
MBE-5050	4,0-6,0	22,5	13,7	5,5	5,0	100		4,20

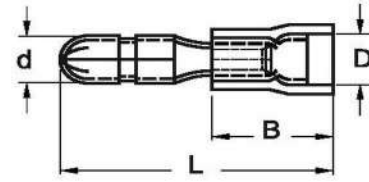

DIŐI TERMİNAL İZOLELİ KABLO UÇLARI

FRANSIZ NORMU (DIN 46237)



ÜRÜN KODU	KABLO KESİTİ (mm ²)	EBATLAR (mm)				AMBALAJ MIKTARI (KUTU)	FİYAT (TL / ADET)	
		L	I1	I2	d			
MBD-1040	0,5-1,5	22,5	10,5	12,5	3,9	200		3,50
MBD-2050	1,5-2,5	22,5	10,5	12,5	4,0	200		4,00
MBD-5050	4,0-6,0	23,5	12,0	13,5	5,5	100		5,00

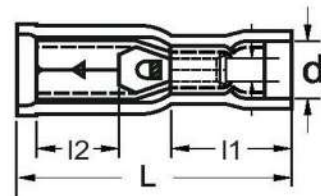

BIÇAK TİP İZOLELİ KABLO UÇLARI

FRANSIZ NORMU (DIN 46237)



ÜRÜN KODU	KABLO KESİTİ (mm ²)	EBATLAR (mm)						AMBALAJ MİKTARI (KUTU)	FİYAT (TL / ADET)	
		L	B	D	d	W	T		RENK	FIYAT
MBCU-101	0,5-1,5	20,4	10,4	4,0	1,7	2,3	0,8	200	■	2,15
MBCU-102	1,5-2,5	20,4	10,4	4,6	2,3	3,0	0,8	200	■	2,60
MBCU-106	4,0-6,0	22,5	13,5	6,9	3,5	3,0	1,0	100	■	5,90



İĞNE TİP İZOLELİ KABLO UÇLARI

FRANSIZ NORMU (DIN 46237)



ÜRÜN KODU	KABLO KESİTİ (mm ²)	EBATLAR (mm)			AMBALAJ MİKTARI (KUTU)	FİYAT (TL / ADET)	
		L	B	F		RENK	FIYAT
MIU-101	0,5-1,5	22,5	10,0	2,0	200	■	1,50
MIU-102	1,5-2,5	22,9	10,0	2,0	200	■	1,85
MIU-106	4,0-6,0	27,3	13,5	2,7	100	■	4,30



PASLANMAZ ÇELİK KABLO BAĞLARI

ÜRÜN KODU	BOYUTLAR (mm)		BAĞLAMA ÇAPI (mm)	AZAMI SIKMA ÇAPI (Kg)	AMBALAJ MİKTARI		FİYAT (TL / ADET)
	L	W			POŞET	KOLİ	
SST-150	150	4.6	50	46	100	8.000	5,60
SST-200	200	4.6	95	46	100	5.000	6,25
SST-300	300	4.6	150	46	100	5.000	6,75
SST-360	360	4.6	180	46	100	2.000	7,25
SST-520	520	4.6	180	46	100	2.000	9,20
SST-600	600	4.6	195	46	100	2.000	11,30
SST-680	680	4.6	95	80	100	2.000	13,75
SLT-300	300	7.9	150	46	100	5.000	7,35
SLT-360	360	7.9	180	46	100	2.000	8,55
SLT-520	520	7.9	180	46	100	2.000	10,75
SLT-600	600	7.9	195	46	100	2.000	12,90
SLT-680	680	7.9	95	80	100	2.000	15,65

